

FCC Information and Copyright

This equipment has been tested and found to comply with the limits of a Class B digital device, pursuant to Part 15 of the FCC Rules. These limits are designed to provide reasonable protection against harmful interference in a residential installation. This equipment generates, uses, and can radiate radio frequency energy and, if not installed and used in accordance with the instructions, may cause harmful interference to radio communications. There is no guarantee that interference will not occur in a particular installation.

The vendor makes no representations or warranties with respect to the contents here and specially disclaims any implied warranties of merchantability or fitness for any purpose. Further the vendor reserves the right to revise this publication and to make changes to the contents here without obligation to notify any party beforehand.

Duplication of this publication, in part or in whole, is not allowed without first obtaining the vendor's approval in writing.

The content of this user's manual is subject to be changed without notice and we will not be responsible for any mistakes found in this user's manual. All the brand and product names are trademarks of their respective companies.

Table of Contents

Chapter 1: Introduction	1
1.1 Before You Start	1
1.2 Package Checklist	1
1.3 Motherboard Features	2
1.4 Rear Panel Connectors (for Ver 6.x)	4
1.5 Rear Panel Connectors (for Ver 5.x)	4
1.6 Motherboard Layout (NF520-A2 TE/NF520-A2SE)	5
1.7 Motherboard Layout (NF520-A2)	6
Chapter 2: Hardware Installation	7
2.1 Installing Central Processing Unit (CPU)	7
2.2 FAN Headers	9
2.3 Installing System Memory	10
2.4 Connectors and Slots	12
Chapter 3: Headers & Jumpers Setup	14
3.1 How to Setup Jumpers	14
3.2 Detail Settings	14
Chapter 4: RAID Functions	21
4.1 Operation System	21
4.2 Raid Arrays	21
4.3 How RAID Works	21
Chapter 5: Useful Help	24
5.1 Driver Installation Note	24
5.2 Award BIOS Beep Code	25
5.3 Extra Information	25
5.4 Troubleshooting	26
Appendencies: SPEC In Other Language	28
German	28
France	30
Italian	32
Spanish	34
Portuguese	36
Polish	38
Russian	40
Arabic	42
Japanese	44

CHAPTER 1: INTRODUCTION

1.1 BEFORE YOU START

Thank you for choosing our product. Before you start installing the motherboard, please make sure you follow the instructions below:

- Prepare a dry and stable working environment with sufficient lighting.
- Always disconnect the computer from power outlet before operation.
- Before you take the motherboard out from anti-static bag, ground yourself properly by touching any safely grounded appliance, or use grounded wrist strap to remove the static charge.
- Avoid touching the components on motherboard or the rear side of the board unless necessary. Hold the board on the edge, do not try to bend or flex the board.
- Do not leave any unfastened small parts inside the case after installation. Loose parts will cause short circuits which may damage the equipment.
- Keep the computer from dangerous area, such as heat source, humid air and water.

1.2 PACKAGE CHECKLIST

- ✦ HDD Cable X 1
- ✦ Serial ATA Cable X 1
- ✦ Rear I/O Panel for ATX Case X 1
- ✦ User's Manual X 1
- ✦ Fully Setup Driver CD X 1
- ✦ FDD Cable X 1 (optional)
- ✦ USB 2.0 Cable X1 (optional)
- ✦ S/PDIF out Cable X 1 (optional)
- ✦ Serial ATA Power Cable X 1 (optional)

Note: The package contents may differ by area or your motherboard version.

1.3 MOTHERBOARD FEATURES

	<i>NF520-A2 TE/NF520-A2 SE</i>	<i>NF520-A2</i>
CPU	Socket AM2 AMDAthlon 64 / Athlon 64 FX / Athlon 64 X2 / Sempron processors AMD 64 Architecture enables 32 and 64 bit computing Supports Hyper Transport and Cool'nQuiet	Socket AM2 AMDAthlon 64 / Athlon 64 FX / Athlon 64 X2 / Sempron processors AMD 64 Architecture enables 32 and 64 bit computing Supports Hyper Transport and Cool'nQuiet
FSB	Support HyperTransport Supports up to 1GHz Bandwidth	Support HyperTransport Supports up to 1GHz Bandwidth
Chipset	nForce 520	nForce 520LE
Super I/O	ITE 8716F Provides the most commonly used legacy Super I/O functionality Low Pin Count Interface Environment Control initiatives, H/W Monitor Fan Speed Controller ITE's "Smart Guardian" function	ITE 8716F Provides the most commonly used legacy Super I/O functionality Low Pin Count Interface Environment Control initiatives, H/W Monitor Fan Speed Controller ITE's "Smart Guardian" function
Main Memory	DDR2 DIMM Slot x 4 Each DIMM supports 256/512/1024/2048 MB DDR2 Max Memory Capacity 8G Dual Channel Mode DDR2 memory module Supports DDR2 533/667/800 Registered DIMM and ECC DIMM is not supported	DDR2 DIMM Slot x 4 Each DIMM supports 256/512/1024/2048 MB DDR2 Max Memory Capacity 8G Dual Channel Mode DDR2 memory module Supports DDR2 533/667/800 Registered DIMM and ECC DIMM is not supported
IDE	Integrated IDE Controller Ultra DMA 33 / 66 / 100 / 133 Bus Master Mode supports PIO Mode 0~4,	Integrated IDE Controller Ultra DMA 33 / 66 / 100 / 133 Bus Master Mode supports PIO Mode 0~4,
SATA	Integrated Serial ATA Controller Data transfer rates up to 3.0 Gb/s. SATA Version 2.0 specification compliant.	Integrated Serial ATA Controller Data transfer rates up to 3.0 Gb/s. SATA Version 2.0 specification compliant.
LAN	Realtek RTL8201CL PHY 10/100 Mb/s auto negotiation Half / Full duplex capability	Realtek RTL8201CL PHY 10/100 Mb/s auto negotiation Half / Full duplex capability

NF520-A2 TE/NF520-A2 SE/NF520-A2

	<i>NF520-A2 TE/NF520-A2 SE</i>		<i>NF520-A2</i>	
Sound	Realtek ALC662 (NF520-A2 TE) (Ver 6.x) Realtek ALC861VD (NF520-A2SE) (Ver 6.x) Realtek ALC888 (Ver 5.x) 5.1 channels audio out (Ver 6.x) 7.1 channels audio out (Ver 5.x) Supports HD Audio		Realtek ALC861VD (Ver 6.x) Realtek ALC888 (Ver 5.x) 5.1 channels audio out (Ver 6.x) 7.1 channels audio out (Ver 5.x) Supports HD Audio	
slots	PCI slot	x3	PCI slot	x3
	PCI Express x16 slot	x1	PCI Express x16 slot	x1
	PCI Express x 1 slot	x2	PCI Express x 1 slot	x2
On Board Connector	Floppy connector	x1	Floppy connector	x1
	Printer Port connector	x1	Printer Port connector	x1
	IDE Connector	x1	IDE Connector	x1
	SATA Connector	x4	SATA Connector	x2
	Front Panel Connector	x1	Front Panel Connector	x1
	Front Audio Connector	x1	Front Audio Connector	x1
	CD-in Connector	x1	CD-in Connector	x1
	S/PDIF out connector	x1	S/PDIF out connector	x1
	CPU Fan header	x1	CPU Fan header	x1
	System Fan header	x1	System Fan header	x1
	USB connector	x3	USB connector	x2
	Chassis open header (optional)	x1	Chassis open header (optional)	x1
	CMOS clear header	x1	CMOS clear header	x1
	Power Connector (24pin)	x1	Power Connector (24pin)	x1
	Power Connector (4pin)	x1	Power Connector (4pin)	x1
Back Panel I/O	PS/2 Keyboard	x1	PS/2 Keyboard	x1
	PS/2 Mouse	x1	PS/2 Mouse	x1
	Serial Port	x1	Serial Port	x1
	LAN port	x1	LAN port	x1
	USB Port	x4	USB Port	x4
	Audio Jack (Ver 6.x)	x3	Audio Jack (Ver 6.x)	x3
	Audio Jack (Ver 5.x)	x6	Audio Jack (Ver 5.x)	x6
Board Size	200 mm (W) x 293 mm (L)		200 mm (W) x 293 mm (L)	
Special Feature	RAID 0 / 1 / 0+1 support		RAID 0 / 1 support	
OS Support	Windows 2000 / XP / VISTA Biostar Reserves the right to add or remove support for any OS with or without notice.		Windows 2000 / XP / VISTA Biostar Reserves the right to add or remove support for any OS with or without notice.	

1.4 REAR PANEL CONNECTORS (FOR VER 6.X)

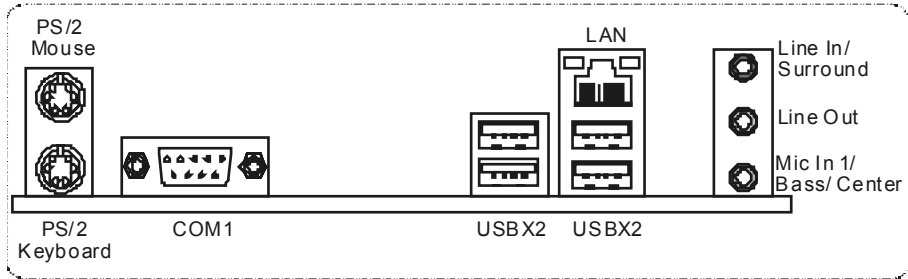

1.5 REAR PANEL CONNECTORS (FOR VER 5.X)

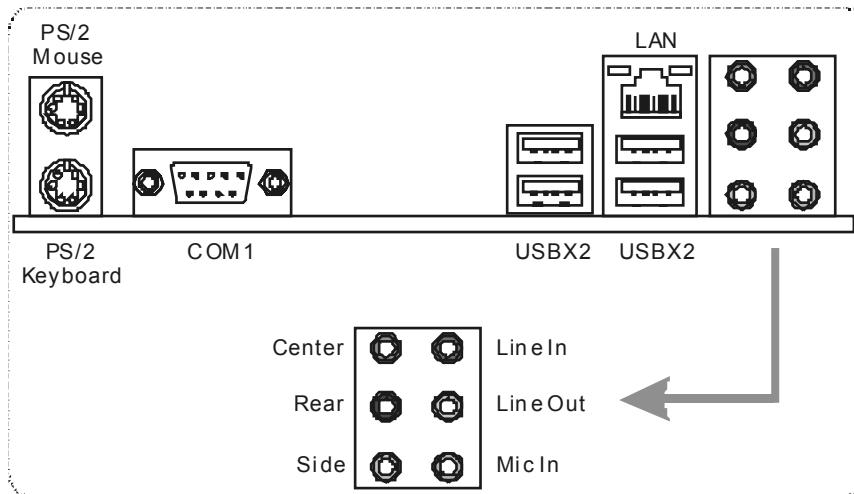

1.6 MOTHERBOARD LAYOUT (NF520-A2 TE/NF520-A2 SE)

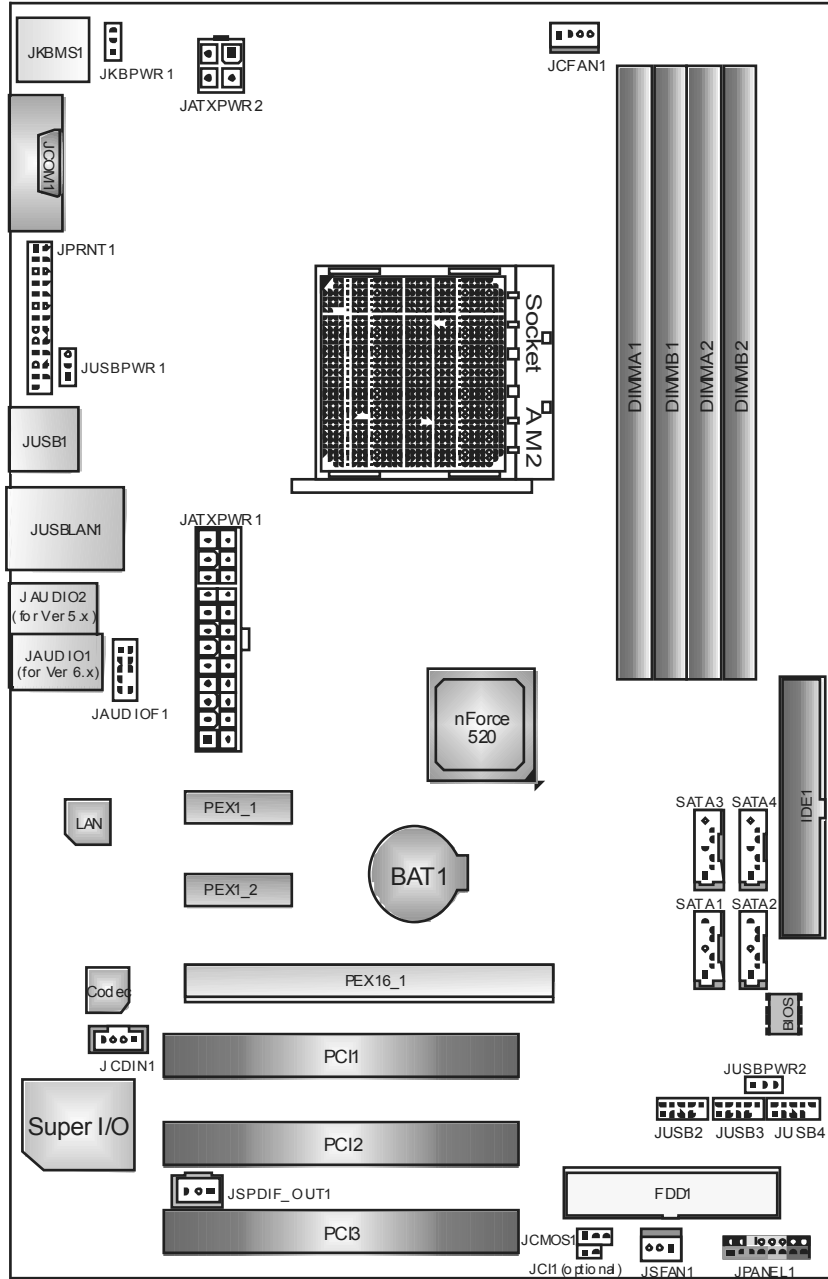

Note: ■ represents the 1st pin.

1.7 MOTHERBOARD LAYOUT (NF520-A2)

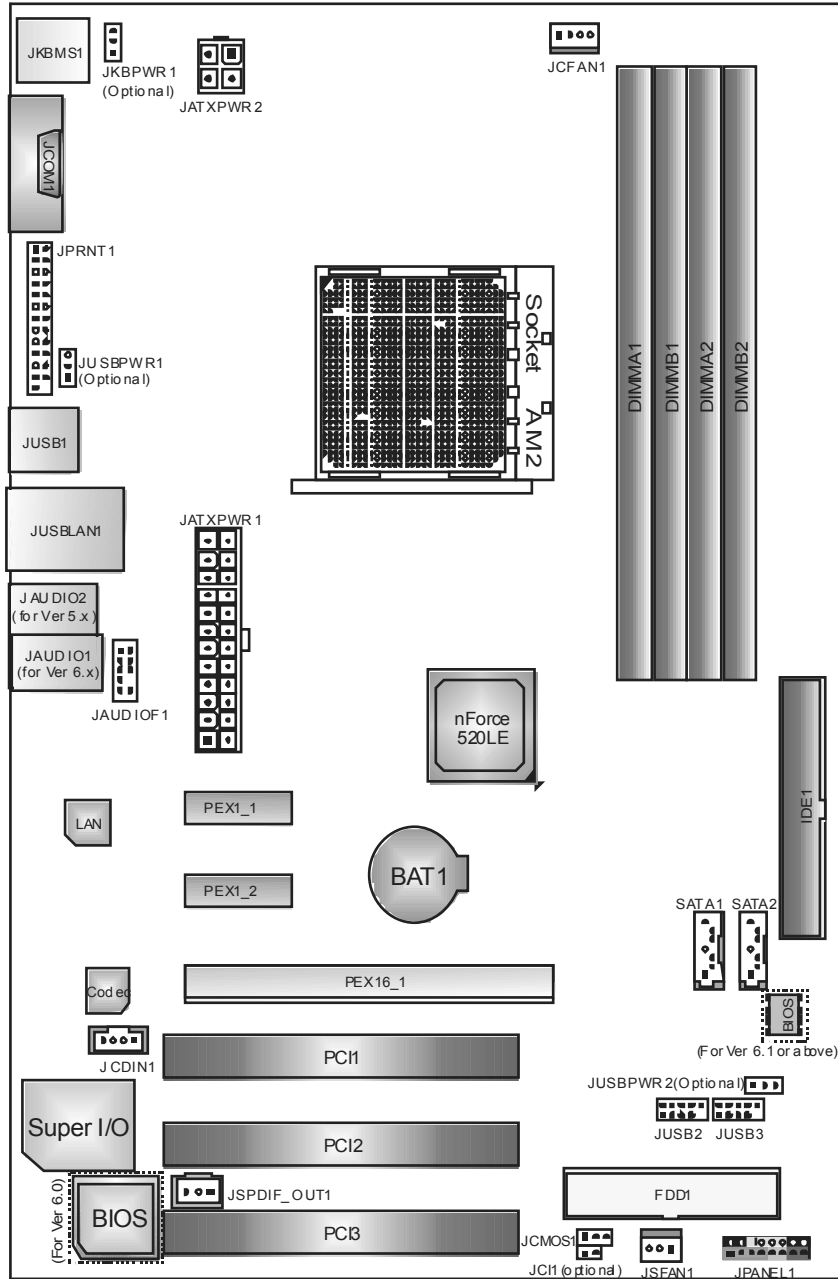

Note: ■ represents the 1st pin.

CHAPTER 2: HARDWARE INSTALLATION

2.1 INSTALLING CENTRAL PROCESSING UNIT (CPU)

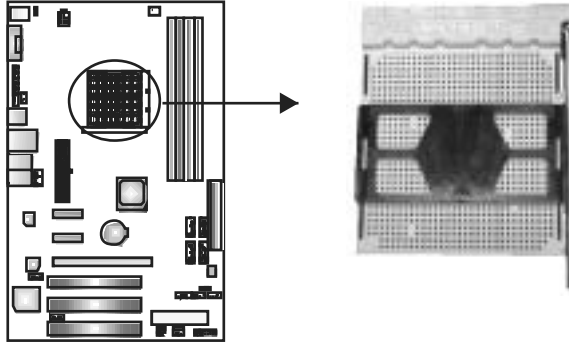

Step 1: Remove the socket protection cap.

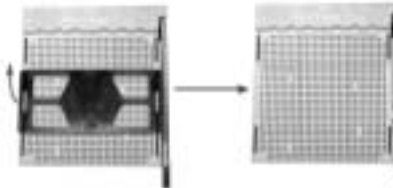

Step 2: Pull the lever toward direction A from the socket and then raise the lever up to a 90-degree angle.

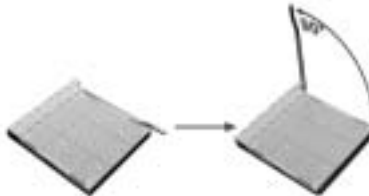

Step 3: Look for the white triangle on socket, and the gold triangle on CPU should point forwards this white triangle. The CPU will fit only in the correct orientation.



Step 4: Hold the CPU down firmly, and then close the lever toward direct B to complete the installation.

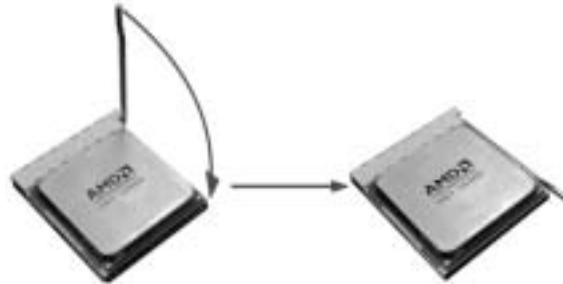

Step 5: Put the CPU Fan on the CPU and buckle it. Connect the CPU FAN power cable to the JCFAN1. This completes the installation.

2.2 FAN HEADERS

These fan headers support cooling-fans built in the computer. The fan cable and connector may be different according to the fan manufacturer. Connect the fan cable to the connector while matching the black wire to pin#1.

JCFAN1: CPU Fan Header

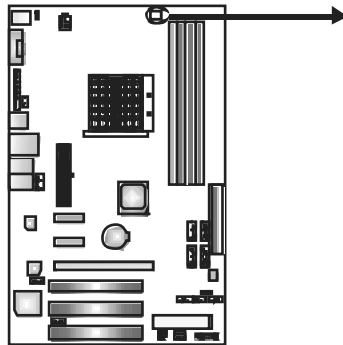

Pin	Assignment
1	Ground
2	+12V
3	FAN RPM rate sense
4	Smart Fan Control

JSFAN1: System Fan Header

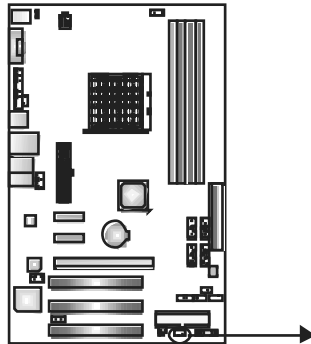

Pin	Assignment
1	Ground
2	+12V
3	FAN RPM rate sense

Note:

The JCFAN1 supports 4-pin head connector, and JSFAN1s supports 3-pin head connector. When connecting with wires onto connectors, please note that the red wire is the positive and should be connected to pin#2, and the black wire is Ground and should be connected to GND.

2.3 INSTALLING SYSTEM MEMORY

A. Memory Modules

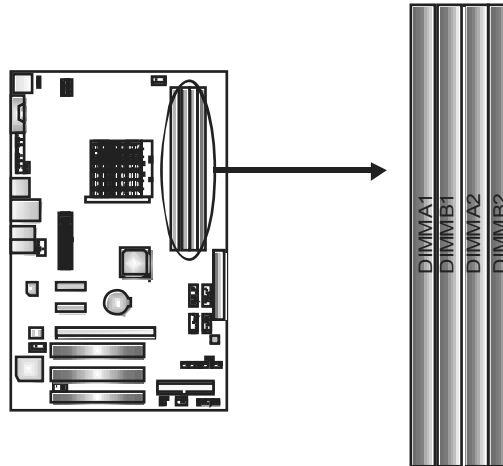

1. Unlock a DIMM slot by pressing the retaining clips outward. Align a DIMM on the slot such that the notch on the DIMM matches the break on the Slot.

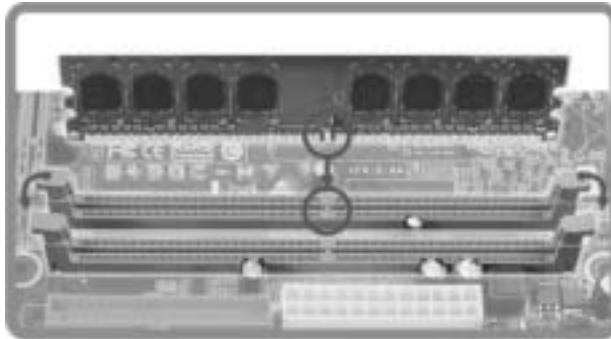

2. Insert the DIMM vertically and firmly into the slot until the retaining chip snap back in place and the DIMM is properly seated.

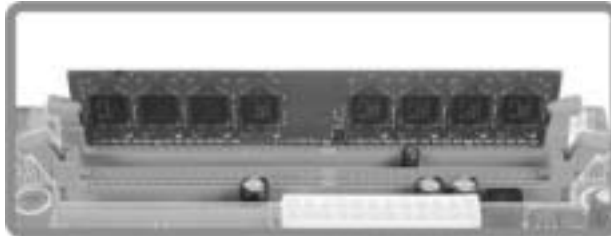

B. Memory Capacity

DIMM Socket Location	DDR2 Module	Total Memory Size
DIMMA1	256MB/512MB/1024MB/2048MB	Max is 8GB.
DIMMB1	256MB/512MB/1024MB/2048MB	
DIMMA2	256MB/512MB/1024MB/2048MB	
DIMMB2	256MB/512MB/1024MB/2048MB	

C. Dual Channel Memory installation

To trigger the Dual Channel function of the motherboard, the memory module must meet the following requirements:

Install memory module of the same density in pairs, shown in the following table.

Dual Channel Status	DIMMA1	DIMMB1	DIMMA2	DIMMB2
Enabled	O	O	X	X
Enabled	X	X	O	O
Enabled	O	O	O	O

(O means memory installed, X means memory not installed.)

The DRAM bus width of the memory module must be the same (x8 or x16)

2.4 CONNECTORS AND SLOTS

FDD1: Floppy Disk Connector

The motherboard provides a standard floppy disk connector that supports 360K, 720K, 1.2M, 1.44M and 2.88M floppy disk types. This connector supports the provided floppy drive ribbon cable.

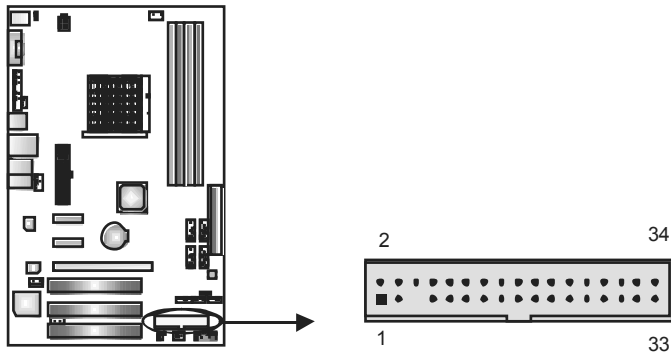

IDE1: Hard Disk Connector

The motherboard has a 32-bit Enhanced PCI IDE Controller that provides PIO Mode 0~4, Bus Master, and Ultra DMA 33/66/100/133 functionality.

The IDE connector can connect a master and a slave drive, so you can connect up to two hard disk drives.

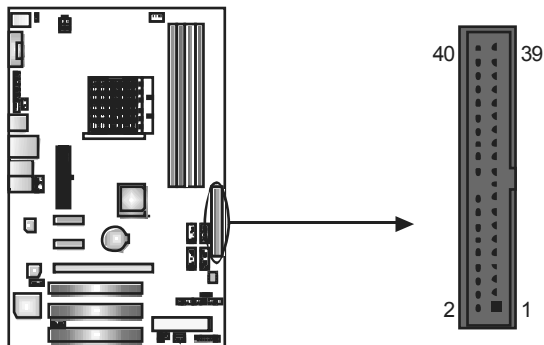

PEX16_1: PCI-Express x16 Slot

- PCI-Express 1.0a compliant.
- Maximum theoretical realized bandwidth of 4GB/s simultaneously per direction, for an aggregate of 8GB/s totally.

PEX1_1/ PEX1_2: PCI-Express x1 Slots

- PCI-Express 1.0a compliant.
- Data transfer bandwidth up to 250MB/s per direction; 500MB/s in total.
- PCI-Express supports a raw bit-rate of 2.5Gb/s on the data pins.
- 2X bandwidth over the traditional PCI architecture.

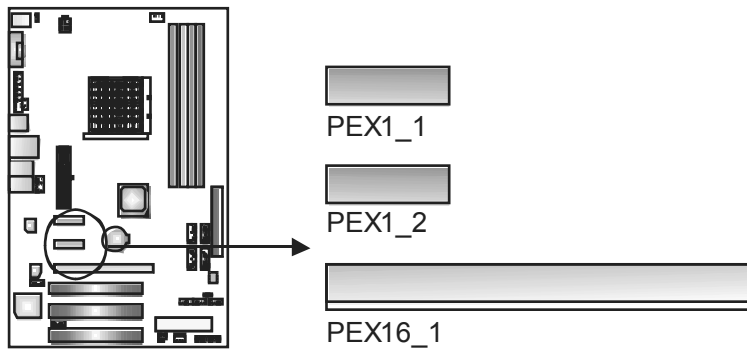

PCI1/PCI2/PCI3: Peripheral Component Interconnect Slots

This motherboard is equipped with 3 standard PCI slots. PCI stands for Peripheral Component Interconnect, and it is a bus standard for expansion cards. This PCI slot is designated as 32 bits.

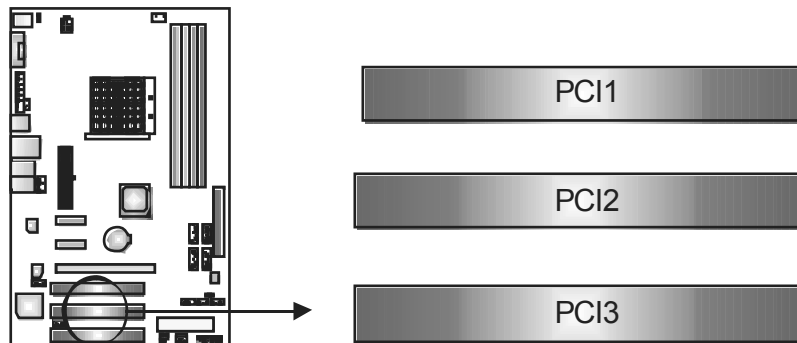

CHAPTER 3: HEADERS & JUMPERS SETUP

3.1 HOW TO SETUP JUMPERS

The illustration shows how to set up jumpers. When the jumper cap is placed on pins, the jumper is “close”, if not, that means the jumper is “open”.



3.2 DETAIL SETTINGS

JPANEL1: Front Panel Header

This 16-pin connector includes Power-on, Reset, HDD LED, Power LED, Sleep button, speaker Connection. It allows user to connect the PC case's front panel switch functions.

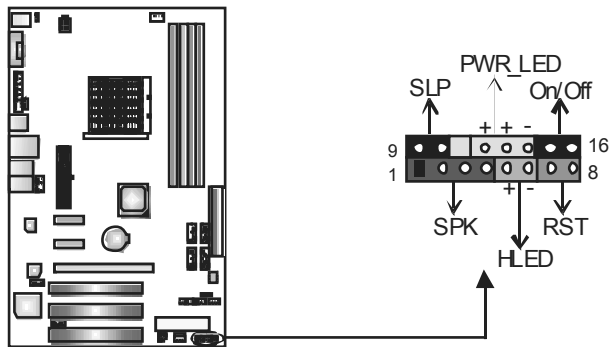

Pin	Assignment	Function	Pin	Assignment	Function
1	+5V	Speaker Connector	9	Sleep control	Sleep button
2	N/A		10	Ground	
3	N/A		11	N/A	N/A
4	Speaker	Hard drive LED	12	Power LED (+)	Power LED
5	HDD LED (+)		13	Power LED (+)	
6	HDD LED (-)	Reset button	14	Power LED (-)	
7	Ground		15	Power button	Power-on button
8	Reset control		16	Ground	

ATX Power Source Connector: JATXPWR1

JATXPWR1 allows user to connect 24-pin power connector on the ATX power supply.

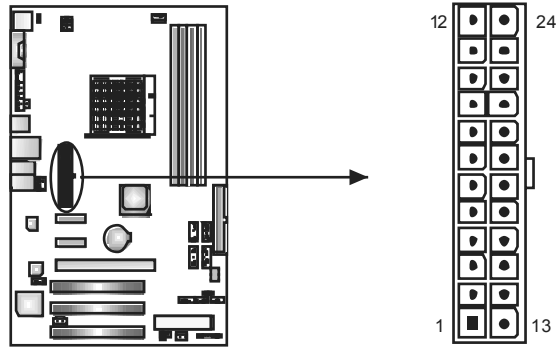

Pin	Assignment	Pin	Assignment
1	+3.3V	13	+3.3V
2	+3.3V	14	-12V
3	Ground	15	Ground
4	+5V	16	PS_ON
5	Ground	17	Ground
6	+5V	18	Ground
7	Ground	19	Ground
8	PW_OK	20	NC
9	Standby Voltage+5V	21	+5V
10	+12V	22	+5V
11	+12V	23	+5V
12	+3.3V	24	Ground

JATXPWR2: ATX Power Source Connector

By connecting this connector, it will provide +12V to CPU power circuit.

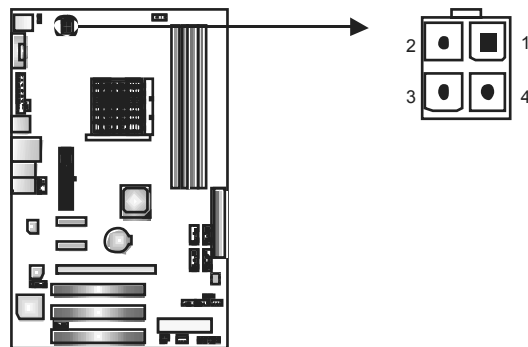

Pin	Assignment
1	+12V
2	+12V
3	Ground
4	Ground

Note:

Before power on the system, please make sure that both JATXPWR1 and JATXPWR2 connectors have been plugged-in.

**JUSB2/JUSB3/JUSB4: Headers for USB 2.0 Ports at Front Panel
(JUSB4 is only for NF520-A2 TE/NF520-A2 SE)**

This header allows user to connect additional USB cable on the PC front panel, and also can be connected with internal USB devices, like USB card reader.

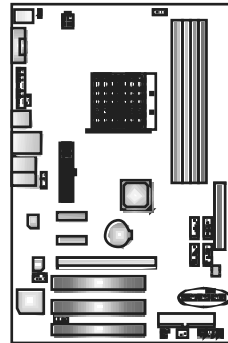

JUSB2 JUSB3 JUSB4
(JUSB4 is only for NF520-A2 TE/
NF520-A2 SE)

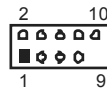

Pin	Assignment
1	+5V (fused)
2	+5V (fused)
3	USB-
4	USB-
5	USB+
6	USB+
7	Ground
8	Ground
9	Key
10	NC

**SATA1/SATA2/SATA3/SATA4: Serial ATA Connectors
(SATA3 and SATA4 are only for NF520-A2 TE/NF520-A2 SE)**

The motherboard has a PCI to SATA Controller with 2 channels SATA interface, it satisfies the SATA 2.0 spec and with transfer rate of 3.0Gb/s.

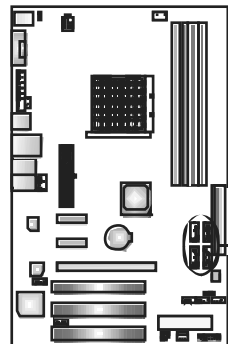

SATA3 SATA4
(Only for NF520-A2 TE/
NF520-A2 SE)



SATA1 SATA2

Pin	Assignment
1	Ground
2	TX+
3	TX-
4	Ground
5	RX-
6	RX+
7	Ground

JAUDIOF1: Front Panel Audio Header

This header allows user to connect the front audio output cable with the PC front panel. This header allows only HD audio front panel connector; AC'97 connector is not acceptable.

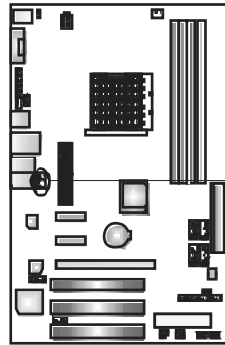

Pin	Assignment
1	Mic Left in
2	Ground
3	Mic Right in
4	GPIO
5	Right line in
6	Jack Sense
7	Front Sense
8	Key
9	Left line in
10	Jack Sense

JCDIN1: CD-ROM Audio-in Connector

This connector allows user to connect the audio source from the variety devices, like CD-ROM, DVD-ROM, PCI sound card, PCI TV turner card etc.

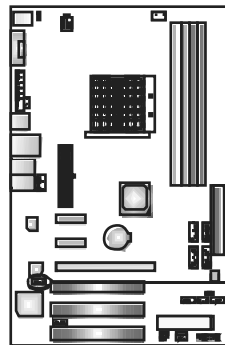

Pin	Assignment
1	Left Channel Input
2	Ground
3	Ground
4	Right Channel Input

JSPDIF_OUT1: Digital Audio-out Connector

This connector allows user to connect the PCI bracket SPDIF output header.

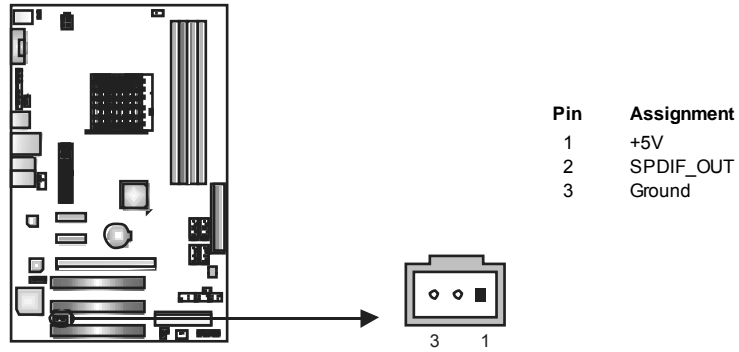

JUSBPWR1/JUSBPWR2: Power Source Headers for USB Ports (Optional for NF520-A2)

Pin 1-2 Close:

JUSBPWR1: +5V for USB ports at JUSB1/JUSBLAN1.

JUSBPWR2: +5V for USB ports at front panel (JUSB2/JUSB3/JUSB4).

Pin 2-3 Close:

JUSBPWR1: +5V STB for USB ports at JUSB1/JUSBLAN1.

JUSBPWR2: +5V STB for USB ports at front panel (JUSB2/JUSB3/JUSB4).

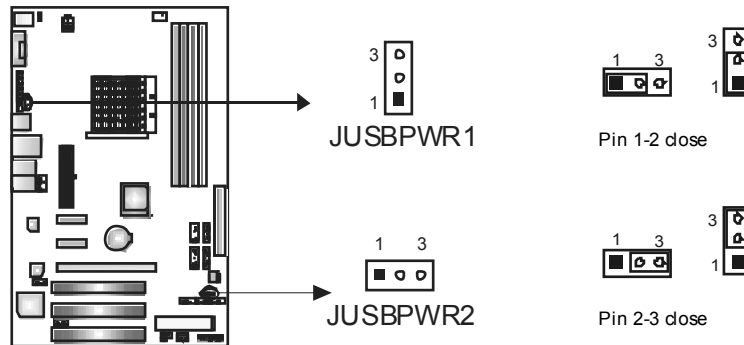

**JKBPWR1: Power Source Header for PS/2 Keyboard and Mouse
(Optional for NF520-A2)**

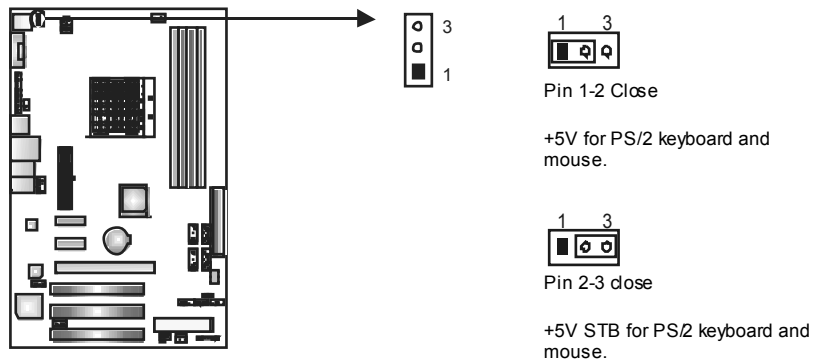

JCMOS1: Clear CMOS Header

By placing the jumper on pin2-3, it allows user to restore the BIOS safe setting and the CMOS data, please carefully follow the procedures to avoid damaging the motherboard.

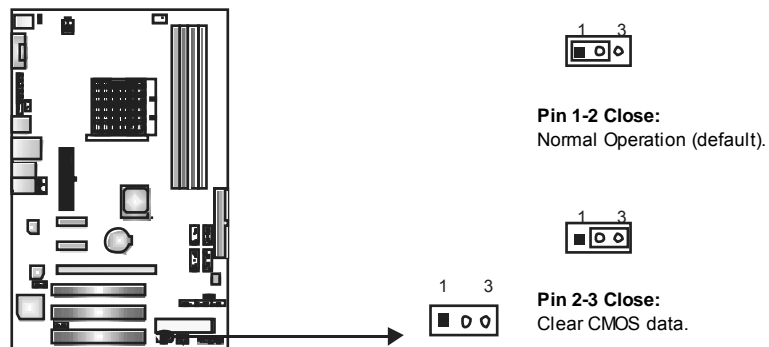

※ Clear CMOS Procedures:

1. Remove AC power line.
2. Set the jumper to "Pin 2-3 close".
3. Wait for five seconds.
4. Set the jumper to "Pin 1-2 close".
5. Power on the AC.
6. Reset your desired password or clear the CMOS data.

JCI1: Chassis Open Header (Optional)

This connector allows system to monitor PC case open status. If the signal has been triggered, it will record to the CMOS and show the message on next boot-up.

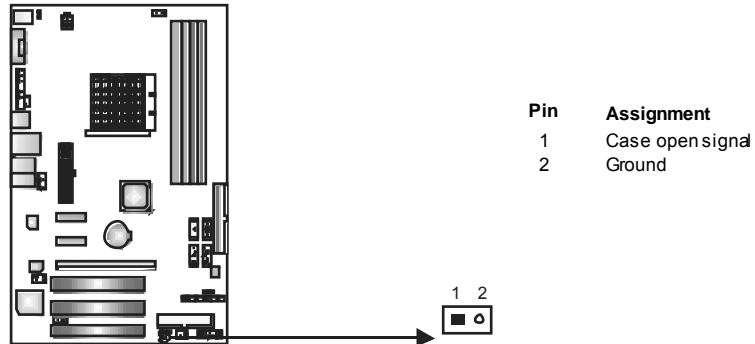

JPRNT1: Printer Port Connector

This header allows you to connector printer on the PC.

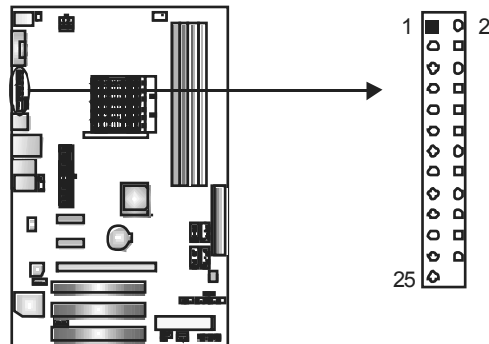

Pin	Assignment	Pin	Assignment
1	-Strobe	14	Ground
2	-ALF	15	Data 6
3	Data 0	16	Ground
4	-Error	17	Data 7
5	Data 1	18	Ground
6	-Init	19	-ACK
7	Data 2	20	Ground
8	-Scltin	21	Busy
9	Data 3	22	Ground
10	Ground	23	PE
11	Data 4	24	Ground
12	Ground	25	SCLT
13	Data 5	26	Key

CHAPTER 4: RAID FUNCTIONS

4.1 OPERATION SYSTEM

Supports Windows XP, Windows 2000 Professional, and Windows Vista.

4.2 RAID ARRAYS

NVRAID supports the following types of RAID arrays:

RAID 0: RAID 0 defines a disk striping scheme that improves disk read and write times for many applications.

RAID 1: RAID 1 defines techniques for mirroring data.

RAID 0+1: RAID 0+1 combines the techniques used in RAID 0 and RAID 1.

4.3 HOW RAID WORKS

RAID 0:

The controller “stripes” data across multiple drives in a RAID 0 array system. It breaks up a large file into smaller blocks and performs disk reads and writes across multiple drives in parallel. The size of each block is determined by the stripe size parameter, which you set during the creation of the RAID set based on the system environment. This technique reduces overall disk access time and offers high bandwidth.

Features and Benefits

- **Drives:** Minimum 2, and maximum is up to 6 or 8. Depending on the platform.
- **Uses:** Intended for non-critical data requiring high data throughput, or any environment that does not require fault tolerance.
- **Benefits:** provides increased data throughput, especially for large files. No capacity loss penalty for parity.
- **Drawbacks:** Does not deliver any fault tolerance. If any drive in the array fails, all data is lost.
- **Fault Tolerance:** No.

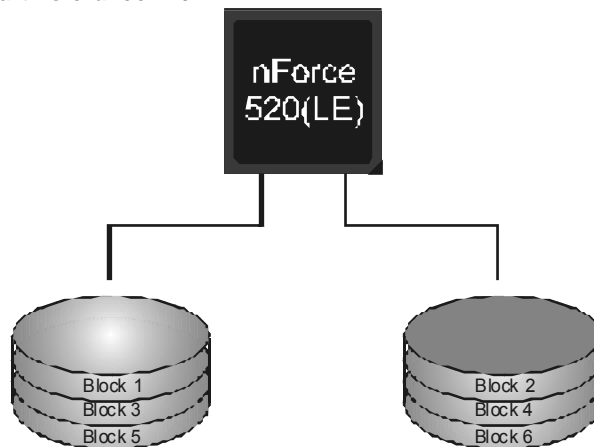

RAID 1:

Every read and write is actually carried out in parallel across 2 disk drives in a RAID 1 array system. The mirrored (backup) copy of the data can reside on the same disk or on a second redundant drive in the array. RAID 1 provides a hot-standby copy of data if the active volume or drive is corrupted or becomes unavailable because of a hardware failure. RAID techniques can be applied for high-availability solutions, or as a form of automatic backup that eliminates tedious manual backups to more expensive and less reliable media.

Features and Benefits

- **Drives:** Minimum 2, and maximum is 2.
- **Uses:** RAID 1 is ideal for small databases or any other application that requires fault tolerance and minimal capacity.
- **Benefits:** Provides 100% data redundancy. Should one drive fail, the controller switches to the other drive.
- **Drawbacks:** Requires 2 drives for the storage space of one drive. Performance is impaired during drive rebuilds.
- **Fault Tolerance:** Yes.

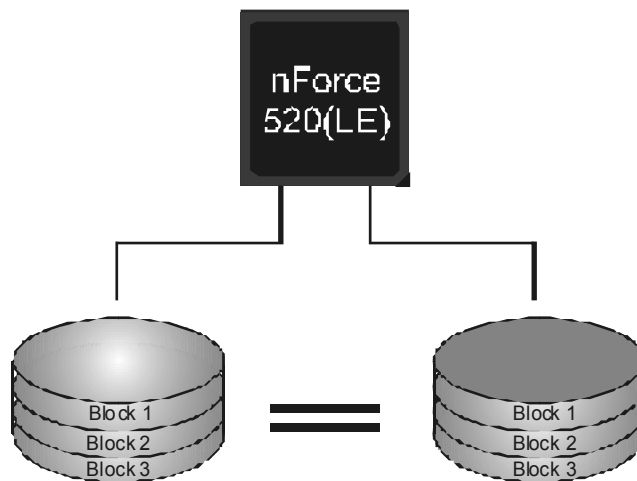

RAID 0+1: (Only for NF520-A2 TE/NF520-A2 SE)

RAID 0 drives can be mirrored using RAID 1 techniques. Resulting in a RAID 0+1 solution for improved performance plus resiliency.

Features and Benefits

- **Drives:** Minimum 4, and maximum is 6 or 8, depending on the platform.
- **Benefits:** Optimizes for both fault tolerance and performance, allowing for automatic redundancy. May be simultaneously used with other RAID levels in an array, and allows for spare disks.
- **Drawbacks:** Requires twice the available disk space for data redundancy, the same as RAID level 1.
- **Fault Tolerance:** Yes.

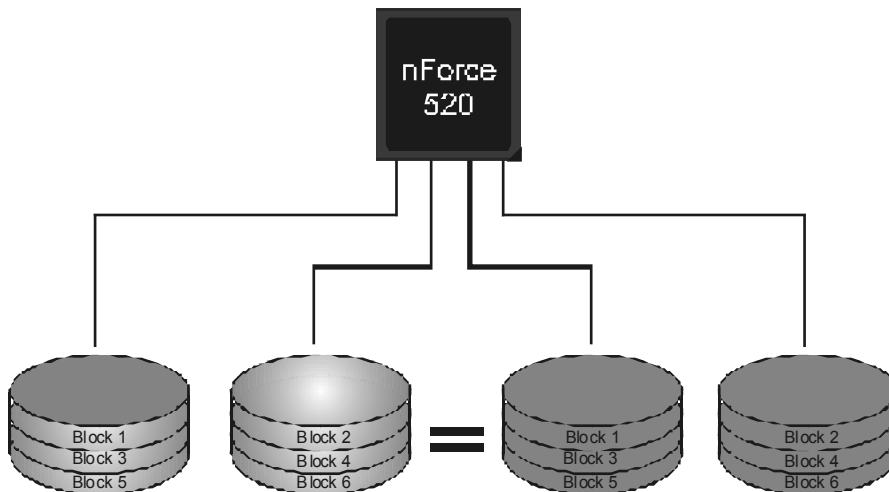

※ For more detailed setup information, please refer to the Driver CD, or go to http://www.nvidia.com/object/IO_28159.html to download the NVIDIA RAID User's Guide.

CHAPTER 5: USEFUL HELP

5.1 DRIVER INSTALLATION NOTE

After you installed your operating system, please insert the Fully Setup Driver CD into your optical drive and install the driver for better system performance.

You will see the following window after you insert the CD



The setup guide will auto detect your motherboard and operating system.

Note:

If this window didn't show up after you insert the Driver CD, please use file browser to locate and execute the file **SETUPEXE** under your optical drive.

A. Driver Installation

To install the driver, please click on the Driver icon. The setup guide will list the compatible driver for your motherboard and operating system. Click on each device driver to launch the installation program.

B. Software Installation

To install the software, please click on the Software icon. The setup guide will list the software available for your system, click on each software title to launch the installation program.

C. Manual

Aside from the paperback manual, we also provide manual in the Driver CD. Click on the Manual icon to browse for available manual.

Note:

You will need Acrobat Reader to open the manual file. Please download the latest version of Acrobat Reader software from

<http://www.adobe.com/products/acrobat/readstep2.html>

5.2 AWARD BIOS BEEP CODE

Beep Sound	Meaning
One long beep followed by two short beeps	Video card not found or video card memory bad
High-low siren sound	CPU overheated System will shut down automatically
One Short beep when system boot-up	No error found during POST
Long beeps every other second	No DRAM detected or install

5.3 EXTRA INFORMATION

CPU Overheated

If the system shutdown automatically after power on system for seconds, that means the CPU protection function has been activated.

When the CPU is over heated, the motherboard will shutdown automatically to avoid a damage of the CPU, and the system may not power on again.

In this case, please double check:

1. The CPU cooler surface is placed evenly with the CPU surface.
2. CPU fan is rotated normally.
3. CPU fan speed is fulfilling with the CPU speed.

After confirmed, please follow steps below to relief the CPU protection function.

1. Remove the power cord from power supply for seconds.
2. Wait for seconds.
3. Plug in the power cord and boot up the system.

Or you can:

1. Clear the CMOS data.
(See "Close CMOS Header: JCMOS1" section)
2. Wait for seconds.
3. Power on the system again.

5.4 TROUBLESHOOTING

Probable	Solution
<ol style="list-style-type: none"> 1. No power to the system at all. Power light don't illuminate, fan inside power supply does not turn on. 2. Indicator light on key board does not turn on. 	<ol style="list-style-type: none"> 1. Make sure power cable is securely plugged in. 2. Replace cable. 3. Contact technical support.
<p>System inoperative. Keyboard lights are on, power indicator lights are lit, and hard drive is spinning.</p>	<p>Using even pressure on both ends of the DIMM, press down firmly until the module snaps into place.</p>
<p>System does not boot from hard disk drive, can be booted from optical drive.</p>	<ol style="list-style-type: none"> 1. Check cable running from disk to disk controller board. Make sure both ends are securely plugged in; check the drive type in the standard CMOS setup. 2. Backing up the hard drive is extremely important. All hard disks are capable of breaking down at any time.
<p>System only boots from optical drive. Hard disk can be read and applications can be used but booting from hard disk is impossible.</p>	<ol style="list-style-type: none"> 1. Back up data and applications files. 2. Reformat the hard drive. Re-install applications and data using backup disks.
<p>Screen message says "Invalid Configuration" or "CMOS Failure."</p>	<p>Review system's equipment. Make sure correct information is in setup.</p>
<p>Cannot boot system after installing second hard drive.</p>	<ol style="list-style-type: none"> 1. Set master/slave jumpers correctly. 2. Run SETUP program and select correct drive types. Call the drive manufacturers for compatibility with other drives.

This page is intentionally left blank.

APPENDENCIES: SPEC IN OTHER LANGUAGE**GERMAN**

	<i>NF520-A2 TE/NF520-A2 SE</i>	<i>NF520-A2</i>
CPU	Sockel AM2 AMD Athlon 64 / Athlon 64 FX / Athlon 64 x2/ Sempron Prozessoren Die AMD 64-Architektur unterstützt eine 32-Bit- und 64-Bit-Datenverarbeitung Unterstützt Hyper Transport und Cool'n'Quiet	Sockel AM2 AMD Athlon 64 / Athlon 64 FX / Athlon 64 x2/ Sempron Prozessoren Die AMD 64-Architektur unterstützt eine 32-Bit- und 64-Bit-Datenverarbeitung Unterstützt Hyper Transport und Cool'n'Quiet
FSB	Unterstützt HyperTransport mit einer Bandbreite von bis zu 1 GHz	Unterstützt HyperTransport mit einer Bandbreite von bis zu 1 GHz
Chipsatz	nForce 520	nForce 520LE
Super E/A	ITE 8716F Bietet die häufig verwendeten alten Super E/A-Funktionen Low Pin Court-Schnittstelle Umgebungskontrolle, Hardware-Überwachung Lüfterdrehzahl-Controller "Smart Guardian"-Funktion von ITE	ITE 8716F Bietet die häufig verwendeten alten Super E/A-Funktionen Low Pin Court-Schnittstelle Umgebungskontrolle, Hardware-Überwachung Lüfterdrehzahl-Controller "Smart Guardian"-Funktion von ITE
Arbeitsspeiche r	DDR2 DIMM-Steckplätze x 4 Jeder DIMM unterstützt 256MB/512MB/1GB/ 2GB DDR2 Max. 8GB Arbeitsspeicher Dual-Kanal DDR2 Speichermodul Unterstützt DDR2 533 / 667 / 800 registrierte DIMMs. ECC DIMMs werden nicht unterstützt.	DDR2 DIMM-Steckplätze x 4 Jeder DIMM unterstützt 256MB/512MB/1GB/ 2GB DDR2 Max. 8GB Arbeitsspeicher Dual-Kanal DDR2 Speichermodul Unterstützt DDR2 533 / 667 / 800 registrierte DIMMs. ECC DIMMs werden nicht unterstützt.
IDE	Integrierter IDE-Controller Ultra DMA 33 / 66 / 100 / 133 Bus Master-Modus Unterstützt PIO-Modus 0~4,	Integrierter IDE-Controller Ultra DMA 33 / 66 / 100 / 133 Bus Master-Modus Unterstützt PIO-Modus 0~4,
SATA II	Integrierter Serial ATA-Controller Datentransfer rate bis zu 3Gb/s Konform mit der SATA-Spezifikation Version 2.0.	Integrierter Serial ATA-Controller Datentransfer rate bis zu 3Gb/s Konform mit der SATA-Spezifikation Version 2.0.
LAN	Realtek RTL8201CL PHY 10 / 100 Mb/s Auto-Negotiation Halb-/Voll duplex-Funktion	Realtek RTL8201CL PHY 10 / 100 Mb/s Auto-Negotiation Halb-/Voll duplex-Funktion

NF520-A2 TE/NF520-A2 SE/NF520-A2

	NF520-A2 TE/NF520-A2 SE	NF520-A2
Audio-Codec	Realtek ALC662 (NF520-A2 TE) (Ver 6.x) Realtek ALC861VD (NF520-A2SE) (Ver 6.x) Realtek ALC888 (Ver 5.x) 5.1-Kanal-Audioausgabe (Ver 6.x) 7.1-Kanal-Audioausgabe (Ver 5.x) Unterstützt High-DefinitionAudio	Realtek ALC861VD (Ver 6.x) Realtek ALC888 (Ver 5.x) 5.1-Kanal-Audioausgabe (Ver 6.x) 7.1-Kanal-Audioausgabe (Ver 5.x) Unterstützt High-DefinitionAudio
Steckplätze	PCI-Steckplatz x3 PCI Express x16 Steckplatz x1 PCI Express x 1-Steckplatz x2	PCI-Steckplatz x3 PCI Express x16 Steckplatz x1 PCI Express x 1-Steckplatz x2
Onboard-Anschluss	Diskettenlaufwerkanschluss x1 Druckeranschluss Anschluss x1 IDE-Anschluss x1 SATA-Anschluss x4 Fronttafelanschluss x1 Front-Audioanschluss x1 CD-IN-Anschluss x1 S/PDIF- Ausgangsanschluss x1 CPU-Lüfter-Sockel x1 System-Lüfter-Sockel x1 "CMOS löschen"-Sockel x1 "Gehäuse offen"-Sockel(optional) x1 USB-Anschluss x3 Stromanschluss (24-pdig) x1 Stromanschluss (4-polig) x1	Diskettenlaufwerkanschluss x1 Druckeranschluss Anschluss x1 IDE-Anschluss x1 SATA-Anschluss x2 Fronttafelanschluss x1 Front-Audioanschluss x1 CD-IN-Anschluss x1 S/PDIF- Ausgangsanschluss x1 CPU-Lüfter-Sockel x1 System-Lüfter-Sockel x1 "CMOS löschen"-Sockel x1 "Gehäuse offen"-Sockel(optional) x1 USB-Anschluss x2 Stromanschluss (24-pdig) x1 Stromanschluss (4-polig) x1
Rückseiten-E/A	PS/2-Tastatur x1 PS/2-Maus x1 Serieller Anschluss x1 LAN-Anschluss x1 USB-Anschluss x4 Audioanschluss (Ver 6.x) x3 Audioanschluss (Ver 5.x) x6	PS/2-Tastatur x1 PS/2-Maus x1 Serieller Anschluss x1 LAN-Anschluss x1 USB-Anschluss x4 Audioanschluss (Ver 6.x) x3 Audioanschluss (Ver 5.x) x6
Platinengröße	200 mm (B) X 293mm (L)	200 mm (B) X 293mm (L)
Sonderfunktionen	Unterstützt RAID 0 / 1/ 0+1	Unterstützt RAID 0 / 1
OS-Unterstützung	Windows 2K / XP / VISTA Biostar behält sich das Recht vor, ohne Ankündigung die Unterstützung für ein Betriebssystem hinzuzufügen oder zu entfernen.	Windows 2K / XP / VISTA Biostar behält sich das Recht vor, ohne Ankündigung die Unterstützung für ein Betriebssystem hinzuzufügen oder zu entfernen.

FRANCE

	NF520-A2 TE/NF520-A2 SE	NF520-A2
UC	Socket AM2 Processeurs AMD Athlon 64 / Athlon 64 FX / Athlon 64 x2/ Sempron L'architecture AMD 64 permet le calcul 32 et 64 bits Prend en charge Hyper Transport et Cool'n'Quiet	Socket AM2 Processeurs AMD Athlon 64 / Athlon 64 FX / Athlon 64 x2/ Sempron L'architecture AMD 64 permet le calcul 32 et 64 bits Prend en charge Hyper Transport et Cool'n'Quiet
Bus frontal	Prend en charge Hyper Transport jusqu'à une bande passante de 1G	Prend en charge Hyper Transport jusqu'à une bande passante de 1G
Chipset	nForce 520	nForce 520LE
Super E/S	ITE 8716F Fournit la fonctionnalité de Super E/S patrimoniales la plus utilisée. Interface à faible compte de broches Initiatives de contrôle environnementales, Moniteur de matériel Contrôleur de vitesse de ventilateur Fonction "Garden intelligent" de l'ITE	ITE 8716F Fournit la fonctionnalité de Super E/S patrimoniales la plus utilisée. Interface à faible compte de broches Initiatives de contrôle environnementales, Moniteur de matériel Contrôleur de vitesse de ventilateur Fonction "Garden intelligent" de l'ITE
Mémoire principale	Fentes DDR2 DIMM x 4 Chaque DIMM prend en charge des DDR2 de 256/512 Mo et 1Go/2Go Capacité mémoire maximale de 8 Go Module de mémoire DDR2 à mode à double voie Prend en charge la DDR2 533 / 667 / 800 Les DIMM à registres et DIMM avec code correcteurs d'erreurs ne sont pas prises en charge	Fentes DDR2 DIMM x 4 Chaque DIMM prend en charge des DDR2 de 256/512 Mo et 1Go/2Go Capacité mémoire maximale de 8 Go Module de mémoire DDR2 à mode à double voie Prend en charge la DDR2 533 / 667 / 800 Les DIMM à registres et DIMM avec code correcteurs d'erreurs ne sont pas prises en charge
IDE	Contrôleur IDE intégré Mode principale de Bus Ultra DMA 33/ 66 / 100 / 133 Prend en charge le mode PIO 0~4,	Contrôleur IDE intégré Mode principale de Bus Ultra DMA 33/ 66 / 100 / 133 Prend en charge le mode PIO 0~4,
SATA II	Contrôleur Serial ATA intégré : Taux de transfert jusqu'à 3 Go/s. Conforme à la spécification SATA Version 2.0	Contrôleur Serial ATA intégré : Taux de transfert jusqu'à 3 Go/s. Conforme à la spécification SATA Version 2.0
LAN	Realtek RTL8201CL PHY 10 / 100 Mb/s négociation automatique Half / Full duplex capability	Realtek RTL8201CL PHY 10 / 100 Mb/s négociation automatique Half / Full duplex capability

NF520-A2 TE/NF520-A2 SE/NF520-A2

	NF520-A2 TE/NF520-A2 SE	NF520-A2
Codec audio	Realtek ALC662 (NF520-A2 TE) (Ver 6.x) Realtek ALC861VD (NF520-A2SE) (Ver 6.x) Realtek ALC888 (ver 5.x) Sortie audio à 5.1 voies (Ver 6.x) Sortie audio à 7.1 voies (Ver 5.x) Prise en charge de l'audio haute définition	Realtek ALC861VD (Ver 6.x) Realtek ALC888 (ver 5.x) Sortie audio à 5.1 voies (Ver 6.x) Sortie audio à 7.1 voies (Ver 5.x) Prise en charge de l'audio haute définition
Fentes	Fente PCI x3 Slot PCI Express x16 x1 Slot PCI Express x 1 x2	Fente PCI x3 Slot PCI Express x16 x1 Slot PCI Express x 1 x2
Connecteur embarqué	Connecteur de disquette x1 Connecteur de Port d'imprimante x1 Connecteur IDE x1 Connecteur SATA x4 Connecteur du panneau avant x1 Connecteur Audio du panneau avant x1 Connecteur d'entrée CD x1 Connecteur de sortie S/PDIF x1 Embase de ventilateur UC x1 Embase de ventilateur système x1 Embase d'effacement CMOS x1 Embase d'ouverture de châssis (en option) x1 Connecteur USB x3 Connecteur d'alimentation (24 broches) x1 Connecteur d'alimentation (4 broches) x1	Connecteur de disquette x1 Connecteur de Port d'imprimante x1 Connecteur IDE x1 Connecteur SATA x2 Connecteur du panneau avant x1 Connecteur Audio du panneau avant x1 Connecteur d'entrée CD x1 Connecteur de sortie S/PDIF x1 Embase de ventilateur UC x1 Embase de ventilateur système x1 Embase d'effacement CMOS x1 Embase d'ouverture de châssis (en option) x1 Connecteur USB x2 Connecteur d'alimentation (24 broches) x1 Connecteur d'alimentation (4 broches) x1
E/S du panneau arrière	Clavier PS/2 x1 Souris PS/2 x1 Port série x1 Port LAN x1 Port USB x4 Fiche audio (Ver 6.x) x3 Fiche audio (Ver 5.x) x6	Clavier PS/2 x1 Souris PS/2 x1 Port série x1 Port LAN x1 Port USB x4 Fiche audio (Ver 6.x) x3 Fiche audio (Ver 5.x) x6
Dimensions de la carte	200 mm (l) X 293 mm (H)	200 mm (l) X 293 mm (H)
Fonctionnalités spéciales	Prise en charge RAID 0 / 1 / 0+1	Prise en charge RAID 0 / 1
Support SE	Windows 2K / XP / VISTA Biostar se réserve le droit d'ajouter ou de supprimer le support de SE avec ou sans préavis.	Windows 2K / XP / VISTA Biostar se réserve le droit d'ajouter ou de supprimer le support de SE avec ou sans préavis.

ITALIAN

	<i>NF520-A2 TE/NF520-A2 SE</i>	<i>NF520-A2</i>
CPU	Socket AM2 Processori AMD Athlon 64 / Athlon 64 FX / Athlon 64 x2/ Sempron L'architettura AMD 64 abilita la computazione 32 e 64 bit Supporto di Hyper Transport e Cool'n'Quiet	Socket AM2 Processori AMD Athlon 64 / Athlon 64 FX / Athlon 64 x2/ Sempron L'architettura AMD 64 abilita la computazione 32 e 64 bit Supporto di Hyper Transport e Cool'n'Quiet
FSB	Supporto di Hyper Transport fino a 1G di larghezza di banda	Supporto di Hyper Transport fino a 1G di larghezza di banda
Chipset	nForce 520	nForce 520LE
Super I/O	ITE 8716F Fornisce le funzionalità legacy Super I/O usate più comunemente. Interfaccia LPC (Low Pin Count) Funzioni di controllo dell'ambiente: Monitoraggio hardware Controller velocità ventolina Funzione "Smart Guardian" di ITE	ITE 8716F Fornisce le funzionalità legacy Super I/O usate più comunemente. Interfaccia LPC (Low Pin Count) Funzioni di controllo dell'ambiente: Monitoraggio hardware Controller velocità ventolina Funzione "Smart Guardian" di ITE
Memoria principale	Alloggi DIMM DDR 2 x 4 Ciascun DIMM supporta DDR2 256/512MB e 1GB/2GB Capacità massima della memoria 8GB Modulo di memoria DDR2 a canale doppio Supporto di DDR2 533 / 667 / 800 DIMM registrati e DIMM ECC non sono supportati	Alloggi DIMM DDR 2 x 4 Ciascun DIMM supporta DDR2 256/512MB e 1GB/2GB Capacità massima della memoria 8GB Modulo di memoria DDR2 a canale doppio Supporto di DDR2 533 / 667 / 800 DIMM registrati e DIMM ECC non sono supportati
IDE	Controller IDE integrato Modalità Bus Master Ultra DMA 33 / 66 / 100 / 133 Supporto modalità PIO Mode 0-4	Controller IDE integrato Modalità Bus Master Ultra DMA 33 / 66 / 100 / 133 Supporto modalità PIO Mode 0-4
SATA II	Controller Serial ATA integrato Velocità di trasferimento dei dati fino a 3 Gb/s. Compatibile specifiche SATA Versione 2.0.	Controller Serial ATA integrato Velocità di trasferimento dei dati fino a 3 Gb/s. Compatibile specifiche SATA Versione 2.0.
LAN	Realtek RTL8201CL PHY Negoziazione automatica 10 / 100 Mb/s Capacità Half / Full Duplex	Realtek RTL8201CL PHY Negoziazione automatica 10 / 100 Mb/s Capacità Half / Full Duplex
Codec audio	Realtek ALC662 (NF520-A2 TE) (Ver 6.x) Realtek ALC861VD (NF520-A2SE) (Ver 6.x) Realtek ALC888 (Ver 5.x) Uscita audio 5.1 canali (Ver 6.x) Uscita audio 7.1 canali (Ver 5.x) Supporto audio High-Definition (HD)	Realtek ALC861VD (Ver 6.x) Realtek ALC888 (Ver 5.x) Uscita audio 5.1 canali (Ver 6.x) Uscita audio 7.1 canali (Ver 5.x) Supporto audio High-Definition (HD)

NF520-A2 TE/NF520-A2 SE/NF520-A2

	NF520-A2 TE/NF520-A2 SE		NF520-A2	
Alloggi	Alloggio PCI	x3	Alloggio PCI	x3
	Alloggio PCI Express x16	x1	Alloggio PCI Express x16	x1
	Alloggio PCI Express x1	x2	Alloggio PCI Express x1	x2
Connettori su scheda	Connettore floppy	x1	Connettore floppy	x1
	Connettore Porta stampante	x1	Connettore Porta stampante	x1
	Connettore IDE	x1	Connettore IDE	x1
	Connettore SATA	x4	Connettore SATA	x2
	Connettore pannello frontale	x1	Connettore pannello frontale	x1
	Connettore audio frontale	x1	Connettore audio frontale	x1
	Connettore CD-in	x1	Connettore CD-in	x1
	Connettore output SPDIF	x1	Connettore output SPDIF	x1
	Collettore ventolina CPU	x1	Collettore ventolina CPU	x1
	Collettore ventolina sistema	x1	Collettore ventolina sistema	x1
	Collettore cancellazione CMOS	x1	Collettore cancellazione CMOS	x1
	Collettore apertura telaio (optional)	x1	Collettore apertura telaio (optional)	x1
	Connettore USB	x3	Connettore USB	x2
	Connettore alimentazione (24 pin)	x1	Connettore alimentazione (24 pin)	x1
Connettore alimentazione (4 pin)	x1	Connettore alimentazione (4 pin)	x1	
I/O pannello posteriore	Tastiera PS/2	x1	Tastiera PS/2	x1
	Mouse PS/2	x1	Mouse PS/2	x1
	Porta seriale	x1	Porta seriale	x1
	Porta LAN	x1	Porta LAN	x1
	Porta USB	x4	Porta USB	x4
	Connettore audio (Ver 6.x)	x3	Connettore audio (Ver 6.x)	x3
Connettore audio (Ver 5.x)	x6	Connettore audio (Ver 5.x)	x6	
Dimensioni scheda	200 mm (larghezza) x 293 mm (altezza)		200 mm (larghezza) x 293 mm (altezza)	
Caratteristiche speciali	Supporto RAID 0 / 1 / 0+1		Supporto RAID 0 / 1	
Sistemi operativi supportati	Windows 2K / XP / VISTA Biostar si riserva il diritto di aggiungere o rimuovere il supporto di qualsiasi sistema operativo senza preavviso.		Windows 2K / XP / VISTA Biostar si riserva il diritto di aggiungere o rimuovere il supporto di qualsiasi sistema operativo senza preavviso.	

SPANISH

	<i>NF520-A2 TE/NF520-A2 SE</i>	<i>NF520-A2</i>
CPU	Conector AM2 Procesadores AMD Athlon 64 / Athlon 64 FX / Athlon 64 x2/ Sempron La arquitectura AMD 64 permite el procesamiento de 32 y 64 bits Soporta las tecnologías Hyper Transport y Cool'nQuiet	Conector AM2 Procesadores AMD Athlon 64 / Athlon 64 FX / Athlon 64 x2/ Sempron La arquitectura AMD 64 permite el procesamiento de 32 y 64 bits Soporta las tecnologías Hyper Transport y Cool'nQuiet
FSB	Admite HyperTransport con un ancho de banda de hasta 1G	Admite HyperTransport con un ancho de banda de hasta 1G
Conjunto de chips	nForce 520	nForce 520LE
Súper E/S	ITE 8716F Le ofrece las funcionalidades heredadas de uso más común Súper E/S. Interfaz de cuenta Low Pin Iniciativas de control de entorno, Monitor hardware Controlador de velocidad de ventilador Función "Guarda inteligente" de ITE	ITE 8716F Le ofrece las funcionalidades heredadas de uso más común Súper E/S. Interfaz de cuenta Low Pin Iniciativas de control de entorno, Monitor hardware Controlador de velocidad de ventilador Función "Guarda inteligente" de ITE
Memoria principal	Ranuras DIMM DDR2 x 4 Cada DIMM admite DDR de 256/512MB y 1GB/2GB Capacidad máxima de memoria de 8GB Módulo de memoria DDR2 de canal Doble Admite DDR2 de 533 / 667 / 800 No admite DIMM registrados o DIMM compatibles con ECC	Ranuras DIMM DDR2 x 4 Cada DIMM admite DDR de 256/512MB y 1GB/2GB Capacidad máxima de memoria de 8GB Módulo de memoria DDR2 de canal Doble Admite DDR2 de 533 / 667 / 800 No admite DIMM registrados o DIMM compatibles con ECC
IDE	Controlador IDE integrado Modo bus maestro Ultra DMA 33/ 66 / 100/ 133 Soporta los Modos PIO 0~4,	Controlador IDE integrado Modo bus maestro Ultra DMA 33/ 66 / 100/ 133 Soporta los Modos PIO 0~4,
SATA II	Controlador ATA Serie Integrado Tasas de transferencia de hasta 3 Gb/s. Compatible con la versión SATA 2.0.	Controlador ATA Serie Integrado Tasas de transferencia de hasta 3 Gb/s. Compatible con la versión SATA 2.0.
Red Local	Realtek RTL8201CL PHY Negociación de 10 / 100 Mb/s Funciones Half/ Full dúplex	Realtek RTL8201CL PHY Negociación de 10 / 100 Mb/s Funciones Half/ Full dúplex
Códex de sonido	Realtek ALC662 (NF520-A2 TE) (Ver 6.x) Realtek ALC861VD (NF520-A2SE) (Ver 6.x) Realtek ALC888 (Ver 5.x) Salida de sonido de 5.1 canales (Ver 6.x) Salida de sonido de 7.1 canales (Ver 5.x) Soporte de sonido de Alta Definición	Realtek ALC861VD (Ver 6.x) Realtek ALC888 (Ver 5.x) Salida de sonido de 5.1 canales (Ver 6.x) Salida de sonido de 7.1 canales (Ver 5.x) Soporte de sonido de Alta Definición

NF520-A2 TE/NF520-A2 SE/NF520-A2

	NF520-A2 TE/NF520-A2 SE		NF520-A2	
Ranuras	Ranura PCI	X3	Ranura PCI	X3
	Ranura PCI Express x16	X1	Ranura PCI Express x16	X1
	Ranura PCI express x 1	X2	Ranura PCI express x 1	X2
Conectores en placa	Conector disco flexible	X1	Conector disco flexible	X1
	Conector Puerto de impresora	X1	Conector Puerto de impresora	X1
	Conector IDE	X1	Conector IDE	X1
	Conector SATA	X4	Conector SATA	X2
	Conector de panel frontal	X1	Conector de panel frontal	X1
	Conector de sonido frontal	X1	Conector de sonido frontal	X1
	Conector de entrada de CD	X1	Conector de entrada de CD	X1
	Conector de salida S/PDIF	X1	Conector de salida S/PDIF	X1
	Cabecera de ventilador de CPU	X1	Cabecera de ventilador de CPU	X1
	Cabecera de ventilador de sistema	X1	Cabecera de ventilador de sistema	X1
	Cabecera de borrado de CMOS	X1	Cabecera de borrado de CMOS	X1
	Cabecera de chasis abierto(opcional)	X1	Cabecera de chasis abierto(opcional)	X1
	Conector USB	X3	Conector USB	X2
	Conector de alimentación (24 patillas)	X1	Conector de alimentación (24 patillas)	X1
	Conector de alimentación (4 patillas)	X1	Conector de alimentación (4 patillas)	X1
Panel trasero de E/S	Teclado PS/2	X1	Teclado PS/2	X1
	Ratón PS/2	X1	Ratón PS/2	X1
	Puerto serie	X1	Puerto serie	X1
	Puerto de red local	X1	Puerto de red local	X1
	Puerto USB	X4	Puerto USB	X4
	Conector de sonido (Ver 6 x)	X3	Conector de sonido (Ver 6 x)	X3
Conector de sonido (Ver 5 x)	X6	Conector de sonido (Ver 5 x)	X6	
Tamaño de la placa	200 mm. (A) X 293 mm. (H)		200 mm. (A) X 293 mm. (H)	
Funciones especiales	Admite RAID 0 / 1 / 0+ 1		Admite RAID 0 / 1	
Soporte de sistema operativo	Windows 2K / XP / VISTA Bióstar se reserva el derecho de añadir o retirar el soporte de cualquier SO con o sin aviso previo.		Windows 2K / XP / VISTA Bióstar se reserva el derecho de añadir o retirar el soporte de cualquier SO con o sin aviso previo.	

PORTUGUESE

	<i>NF520-A2 TE/NF520-A2 SE</i>	<i>NF520-A2</i>
CPU	Socket AM2 Processadores AMD Athlon 64 / Athlon 64 FX / Athlon 64 x2 / Sempron A arquitectura AMD 64 permite uma computação de 32 e 64 bits Suporta as tecnologias Hyper Transport e Cool'nQuiet	Socket AM2 Processadores AMD Athlon 64 / Athlon 64 FX / Athlon 64 x2 / Sempron A arquitectura AMD 64 permite uma computação de 32 e 64 bits Suporta as tecnologias Hyper Transport e Cool'nQuiet
FSB	Suporta a tecnologia HyperTransport com uma largura de banda até 1G	Suporta a tecnologia HyperTransport com uma largura de banda até 1G
Chipset	nForce 520	nForce 520LE
Especificação do Super I/O	ITE 8716F Proporciona as funcionalidades mais utilizadas em termos da especificação Super I/O. Interface LPC (Low Pin Count). Iniciativas para controlo do ambiente Monitorização do hardware Controlador da velocidade da ventoinha Função "Smart Guardian" da ITE	ITE 8716F Proporciona as funcionalidades mais utilizadas em termos da especificação Super I/O. Interface LPC (Low Pin Count). Iniciativas para controlo do ambiente Monitorização do hardware Controlador da velocidade da ventoinha Função "Smart Guardian" da ITE
Memória principal	Ranuras DIMM DDR2 x 4 Cada módulo DIMM suporta uma memória DDR2 de 256/512 MB & 1 GB/2 GB Capacidade máxima de memória: 8 GB Módulo de memória DDR2 de canal duplo Suporta módulos DDR2 533 / 667 / 800 Os módulos DIMM registados e os DIMM ECC não são suportados	Ranuras DIMM DDR2 x 4 Cada módulo DIMM suporta uma memória DDR2 de 256/512 MB & 1 GB/2 GB Capacidade máxima de memória: 8 GB Módulo de memória DDR2 de canal duplo Suporta módulos DDR2 533 / 667 / 800 Os módulos DIMM registados e os DIMM ECC não são suportados
IDE	Controlador IDE integrado Modo Bus master Ultra DMA 33 / 66 / 100 / 133 Suporta o modo PIO 0~4,	Controlador IDE integrado Modo Bus master Ultra DMA 33 / 66 / 100 / 133 Suporta o modo PIO 0~4,
SATA II	Controlador Serial ATA integrado Velocidades de transmissão de dados até 3 Gb/s. Compatibilidade com a especificação SATA versão 2.0.	Controlador Serial ATA integrado Velocidades de transmissão de dados até 3 Gb/s. Compatibilidade com a especificação SATA versão 2.0.
LAN	Realtek RTL8201CL PHY Auto negociação de 10 / 100 Mb/s Capacidade semi/full-duplex	Realtek RTL8201CL PHY Auto negociação de 10 / 100 Mb/s Capacidade semi/full-duplex
Codec de som	Realtek ALC662 (NF520-A2 TE) (Ver 6.x) Realtek ALC861VD (NF520-A2SE) (Ver 6.x) Realtek ALC 888 (Ver 5.x) Saída de áudio de 5.1 canais (Ver 6.x) Saída de áudio de 7.1 canais (Ver 5.x) Suporta a especificação High-Definition Audio	Realtek ALC 861VD (Ver 6.x) Realtek ALC 888 (Ver 5.x) Saída de áudio de 5.1 canais (Ver 6.x) Saída de áudio de 7.1 canais (Ver 5.x) Suporta a especificação High-Definition Audio

NF520-A2 TE/NF520-A2 SE/NF520-A2

	NF520-A2 TE/NF520-A2 SE		NF520-A2	
Ranhuras	Ranhura PCI	x3	Ranhura PCI	x3
	Ranhura PCI Express x16	x1	Ranhura PCI Express x16	x1
	Ranhura PCI Express x 1	x2	Ranhura PCI Express x 1	x2
Conectores na placa	Conector da unidade de disquetes	x1	Conector da unidade de disquetes	x1
	Conector da para impressora	x1	Conector da para impressora	x1
	Conector IDE	x1	Conector IDE	x1
	Conector SATA	x4	Conector SATA	x2
	Conector do painel frontal	x1	Conector do painel frontal	x1
	Conector de áudio frontal	x1	Conector de áudio frontal	x1
	Conector para entrada de CDs	x1	Conector para entrada de CDs	x1
	Conector de saída S/PDIF	x1	Conector de saída S/PDIF	x1
	Conector da verticinha da CPU	x1	Conector da verticinha da CPU	x1
	Conector da verticinha do sistema	x1	Conector da verticinha do sistema	x1
	Conector para limpeza do CMOS	x1	Conector para limpeza do CMOS	x1
	Conector para detecção da abertura do chassis (opcional)	x1	Conector para detecção da abertura do chassis (opcional)	x1
	Conector USB	x3	Conector USB	x2
	Conector de alimentação (24 pinos)	x1	Conector de alimentação (24 pinos)	x1
Conector de alimentação (4 pinos)	x1	Conector de alimentação (4 pinos)	x1	
Entradas/Saídas no painel traseiro	Teclado PS/2	x1	Teclado PS/2	x1
	Rato PS/2	x1	Rato PS/2	x1
	Porta série	x1	Porta série	x1
	Porta LAN	x1	Porta LAN	x1
	Porta USB	x4	Porta USB	x4
	Tomada de áudio (Ver 6.x)	x3	Tomada de áudio (Ver 6.x)	x3
	Tomada de áudio (Ver 5.x)	x6	Tomada de áudio (Ver 5.x)	x6
Tamanho da placa	200 mm (L) X 293mm (A)		200 mm (L) X 293mm (A)	
Características especiais	Suporta as funções RAID 0 / 1 / 0+1		Suporta as funções RAID 0 / 1	
Sistemas operativos suportados	Windows 2K / XP / VISTA A Biostar reserva-se o direito de adicionar ou remover suporte para qualquer sistema operativo com ou sem aviso prévio.		Windows 2K / XP / VISTA A Biostar reserva-se o direito de adicionar ou remover suporte para qualquer sistema operativo com ou sem aviso prévio.	

POLISH

	<i>NF520-A2 TE/NF520-A2 SE</i>	<i>NF520-A2</i>
Procesor	Socket AM2 AMDAthlon 64 / Athlon 64 FX / Athlon 64 x2/ Sempron Procesory Architektura AMD 64 umożliwia przetwarzanie 32 i 64 bitowe Obsługa Hyper Transport oraz Cool'n'Quiet	Socket AM2 AMDAthlon 64 / Athlon 64 FX / Athlon 64 x2/ Sempron Procesory Architektura AMD 64 umożliwia przetwarzanie 32 i 64 bitowe Obsługa Hyper Transport oraz Cool'n'Quiet
FSB	Obsługa HyperTransport o szerokości pasma do 1G	Obsługa HyperTransport o szerokości pasma do 1G
Chipset	nForce 520	nForce 520LE
Pamięć główna	Gniazda DDR2 DIMM x 4 Każde gniazdo DIMM obsługuje moduły 256/512MB oraz 1GB/2GB DDR2 Maks. wielkość pamięci 8GB Moduł pamięci DDR2 z trybem podwójnego kanału Obsługa DDR2 533 / 667 / 800 Brak obsługi Registered DIMM oraz ECC DIMM	Gniazda DDR2 DIMM x 4 Każde gniazdo DIMM obsługuje moduły 256/512MB oraz 1GB/2GB DDR2 Maks. wielkość pamięci 8GB Moduł pamięci DDR2 z trybem podwójnego kanału Obsługa DDR2 533 / 667 / 800 Brak obsługi Registered DIMM oraz ECC DIMM
Super I/O	ITE 8716F Zapewnia najbardziej powszechne funkcje Super I/O. Interfejs Low Pin Court Funkcje kontroli warunków pracy, Monitor H/W Kontroler prędkości wentylatora Funkcja ITE "Smart Guardian"	ITE 8716F Zapewnia najbardziej powszechne funkcje Super I/O. Interfejs Low Pin Court Funkcje kontroli warunków pracy, Monitor H/W Kontroler prędkości wentylatora Funkcja ITE "Smart Guardian"
IDE	Zintegrowany kontroler IDE Ultra DMA 33 / 66 / 100 / 133 Tryb Bus Master obsługa PIO tryb 0~4,	Zintegrowany kontroler IDE Ultra DMA 33 / 66 / 100 / 133 Tryb Bus Master obsługa PIO tryb 0~4,
SATA II	Zintegrowany kontroler Serial ATA Transfer danych do 3 Gb/s. Zgodność ze specyfikacją SATA w wersji 2.0.	Zintegrowany kontroler Serial ATA Transfer danych do 3 Gb/s. Zgodność ze specyfikacją SATA w wersji 2.0.
LAN	Realtek RTL8201CL PHY 10 / 100 Mb/s z automatyczną negocjacją szybkości Działanie w trybie półowicznego / pełnego dupleksu	Realtek RTL8201CL PHY 10 / 100 Mb/s z automatyczną negocjacją szybkości Działanie w trybie półowicznego / pełnego dupleksu

NF520-A2 TE/NF520-A2 SE/NF520-A2

	NF520-A2 TE/NF520-A2 SE	NF520-A2
Kodek dźwiękowy	Realtek ALC662 (NF520-A2 TE) (Ver 6.x) Realtek ALC861VD (NF520-A2SE) (Ver 6.x) Realtek ALC 888 (Ver 5.x) 5.1 kanałowe wyjście audio (Ver 6.x) 7.1 kanałowe wyjście audio (Ver 5.x) Obsługa High-DefinitionAudio	Realtek ALC 861VD (Ver 6.x) Realtek ALC 888 (Ver 5.x) 5.1 kanałowe wyjście audio (Ver 6.x) 7.1 kanałowe wyjście audio (Ver 5.x) Obsługa High-DefinitionAudio
Gniazda	Gniazdo PCI x3 Gniazdo PCI Express x16 x1 Gniazdo PCI Express x 1 x2	Gniazdo PCI x3 Gniazdo PCI Express x16 x1 Gniazdo PCI Express x 1 x2
Złącza wbudowane	Złącze napędu dyskietek x1 Złącze Port drukarki x1 Złącze IDE x1 Złącze SATA x4 Złącze panela przedniego x1 Przednie złącze audio x1 Złącze wejścia CD x1 Złącze wyjścia S/PDIF x1 Złącze główkowe wentylatora procesora x1 Złącze główkowe wentylatora systemowego x1 Złącze główkowe kasowania CMOS x1 Złącze główkowe otwarcia obudowy (opcja) x1 Złącze USB x3 Złącze zasilania (24 pinowe) x1 Złącze zasilania (4 pinowe) x1	Złącze napędu dyskietek x1 Złącze Port drukarki x1 Złącze IDE x1 Złącze SATA x2 Złącze panela przedniego x1 Przednie złącze audio x1 Złącze wejścia CD x1 Złącze wyjścia S/PDIF x1 Złącze główkowe wentylatora procesora x1 Złącze główkowe wentylatora systemowego x1 Złącze główkowe kasowania CMOS x1 Złącze główkowe otwarcia obudowy (opcja) x1 Złącze USB x2 Złącze zasilania (24 pinowe) x1 Złącze zasilania (4 pinowe) x1
Back Panel I/O	Klawiatura PS/2 x1 Mysz PS/2 x1 Port szeregowy x1 Port LAN x1 Port USB x4 Gniazdo audio (Ver 6.x) x3 Gniazdo audio (Ver 5.x) x6	Klawiatura PS/2 x1 Mysz PS/2 x1 Port szeregowy x1 Port LAN x1 Port USB x4 Gniazdo audio (Ver 6.x) x3 Gniazdo audio (Ver 5.x) x6
Wymiary płyty	200 mm (S) X 293 mm (W)	200 mm (S) X 293 mm (W)
Funkcje specjalne	Obsługa RAID 0 / 1 / 0+1	Obsługa RAID 0 / 1
Obsługa systemu operacyjnego	Windows 2K / XP / VISTA Biostar zastrzega sobie prawo dodawania lub odwoływania obsługi dowolnego systemu operacyjnego bez powiadomienia.	Windows 2K / XP / VISTA Biostar zastrzega sobie prawo dodawania lub odwoływania obsługi dowolnego systemu operacyjnego bez powiadomienia.

RUSSIAN

	<i>NF520-A2 TE/NF520-A2 SE</i>	<i>NF520-A2</i>
CPU (центральный процессор)	Гнездо AM2 Процессоры AMD Athlon 64 / Athlon 64 FX / Athlon 64X2 / Sempron Архитектура AMD 64 разрешать обработка данных на 32 и 64 бит Поддержка Hyper Transport и Cool'nQuiet	Гнездо AM2 Процессоры AMD Athlon 64 / Athlon 64 FX / Athlon 64X2 / Sempron Архитектура AMD 64 разрешать обработка данных на 32 и 64 бит Поддержка Hyper Transport и Cool'nQuiet
FSB	Поддержка HyperTransport с пропускной способностью до 1G	Поддержка HyperTransport с пропускной способностью до 1G
Набор микросхем	nForce 520	nForce 520LE
Основная память	Слоты DDR2 DIMM x 4 Каждый модуль DIMM поддерживает 256/512МБ & 1ГБ/2ГБ DDR2 Максимальная ёмкость памяти 8 ГБ Модуль памяти с двухканальным режимом DDR2 Поддержка DDR2 533 / 667 / 800 Не поддерживает зарегистрированные модули DIMM and ECC DIMM	Слоты DDR2 DIMM x 4 Каждый модуль DIMM поддерживает 256/512МБ & 1ГБ/2ГБ DDR2 Максимальная ёмкость памяти 8 ГБ Модуль памяти с двухканальным режимом DDR2 Поддержка DDR2 533 / 667 / 800 Не поддерживает зарегистрированные модули DIMM and ECC DIMM
Super I/O	ITE 8716F Обеспечивает наиболее используемые действующие функциональные возможности Super I/O. Интерфейс с низким количеством выводов Инициативы по охране окружающей среды, Аппаратный монитор Регулятор скорости Функция ITE "Smart Guardian" (Интеллектуальная защита)	ITE 8716F Обеспечивает наиболее используемые действующие функциональные возможности Super I/O. Интерфейс с низким количеством выводов Инициативы по охране окружающей среды, Аппаратный монитор Регулятор скорости Функция ITE "Smart Guardian" (Интеллектуальная защита)
IDE	Встроенное устройство управления встроенными интерфейсами устройств Режим "хозяина" шины Ultra DMA 33 / 66 / 100 / 133 Поддержка режима PIO 0~4,	Встроенное устройство управления встроенными интерфейсами устройств Режим "хозяина" шины Ultra DMA 33 / 66 / 100 / 133 Поддержка режима PIO 0~4,
SATA	Встроенное последовательное устройство управления ATA скорость передачи данных до 3 гигабит/с. Соответствие спецификации SATA версия 2.0.	Встроенное последовательное устройство управления ATA скорость передачи данных до 3 гигабит/с. Соответствие спецификации SATA версия 2.0.
Локальная сеть	Realtek RTL8201CL PHY Автоматическое согласование 10 / 100 Мб/с Частичная / полная дуплексная способность	Realtek RTL8201CL PHY Автоматическое согласование 10 / 100 Мб/с Частичная / полная дуплексная способность
Звуковой кодек	Realtek ALC662 (NF520-A2 TE) (Ver 6.x) Realtek ALC861VD (NF520-A2 SE) (Ver 6.x) Realtek ALC 888 (Ver 5.x) 5.1канальный звуковой выход (Ver 6.x) 7.1канальный звуковой выход (Ver 5.x) Звуковая поддержка High-Definition	Realtek ALC 861VD (Ver 6.x) Realtek ALC 888 (Ver 5.x) 5.1канальный звуковой выход (Ver 6.x) 7.1канальный звуковой выход (Ver 5.x) Звуковая поддержка High-Definition

NF520-A2 TE/NF520-A2 SE/NF520-A2

	NF520-A2 TE/NF520-A2 SE		NF520-A2	
Слоты	Слот PCI	x3	Слот PCI	x3
	Слот PCI Express x16	x1	Слот PCI Express x16	x1
	Слот PCI Express x 1	x2	Слот PCI Express x 1	x2
Встроенный разъем	Разъем НГМД	x1	Разъем НГМД	x1
	Разъем Порт подключения принтера	x1	Разъем Порт подключения принтера	x1
	Разъем IDE	x1	Разъем IDE	x1
	Разъем SATA	x4	Разъем SATA	x2
	Разъем на лицевой панели	x1	Разъем на лицевой панели	x1
	Входной звуковой разъем	x1	Входной звуковой разъем	x1
	Разъем ввода для CD	x1	Разъем ввода для CD	x1
	Разъем вывода для S/PDIF	x1	Разъем вывода для S/PDIF	x1
	Контактирующее приспособление вентилятора центрального процессора	x1	Контактирующее приспособление вентилятора центрального процессора	x1
	Контактирующее приспособление вентилятора системы	x1	Контактирующее приспособление вентилятора системы	x1
	Открытое контактирующее приспособление CMOS	x1	Открытое контактирующее приспособление CMOS	x1
	Шасси открытого контактирующего приспособления (дополнительно)	x1	Шасси открытого контактирующего приспособления (дополнительно)	x1
	USB-разъем	x3	USB-разъем	x2
	Разъем питания (24 вывод)	x1	Разъем питания (24 вывод)	x1
Разъем питания (4 вывод)	x1	Разъем питания (4 вывод)	x1	
Задняя панель средств ввода-вывода	Клавиатура PS/2	x1	Клавиатура PS/2	x1
	Мышь PS/2	x1	Мышь PS/2	x1
	Последовательный порт	x1	Последовательный порт	x1
	Порт LAN	x1	Порт LAN	x1
	USB-порт	x4	USB-порт	x4
	Гнездо для подключения наушников (Ver 6.x)	x3	Гнездо для подключения наушников (Ver 6.x)	x3
	Гнездо для подключения наушников (Ver 5.x)	x6	Гнездо для подключения наушников (Ver 5.x)	x6
Размер панели	200 мм (Ш) X 293 мм (В)		200 мм (Ш) X 293 мм (В)	
Специальные технические характеристики	Поддержка RAID 0/ 1 / 0+1		Поддержка RAID 0/ 1	
Поддержка OS	Windows 2K /XP /VISTA Biostar сохраняет за собой право добавлять или удалять средства обеспечения для OS с или без предварительного уведомления.		Windows 2K /XP /VISTA Biostar сохраняет за собой право добавлять или удалять средства обеспечения для OS с или без предварительного уведомления.	

ARABIC

NF520-A2	NF520-A2 TE/NF520-A2 SE	
AM2 مقبس AMD Athlon 64 / Athlon 64FX / Athlon 64 x2/ Sempron إجراء العمليات لحلوية بسعة 32 و 64 بت AMD تمكن تقنية Hyper Transport و Cod'nQuiet تدعم تقنية	AM2 مقبس AMD Athlon 64 / Athlon 64FX / Athlon 64 x2/ Sempron إجراء العمليات لحلوية بسعة 32 و 64 بت AMD تمكن تقنية Hyper Transport و Cod'nQuiet تدعم تقنية	وحدة المعالجة المركبة
تردد 1000 بتتردد يصل إلى Hyper Transport تدعم تقنية	تردد 1000 بتتردد يصل إلى Hyper Transport تدعم تقنية	النقل الأممي الجانبي
nForce 520LE	nForce 520	مجموعة الشرائح
عدد 4 فتحة DDR2 DIMM ميغا 256/512 سعة DDR2 دعم ذاكرة من نوع DIMM تدعم كل فتحة بليت و 1/2 جيجا بليت سعة ذاكرة قصوى 8 جيجا بايت مزوجة لفتحة DDR2 وحدة ذاكرة ساعات 533 / 667 / 800 ميغا بايت DDR2 تدعم الذاكرة من نوع ECC ونك التي لا تتوافق مع DIMM لا تدعم نقل الذاكرة	عدد 4 فتحة DDR2 DIMM ميغا 256/512 سعة DDR2 دعم ذاكرة من نوع DIMM تدعم كل فتحة بليت و 1/2 جيجا بليت سعة ذاكرة قصوى 8 جيجا بايت مزوجة لفتحة DDR2 وحدة ذاكرة ساعات 533 / 667 / 800 ميغا بايت DDR2 تدعم الذاكرة من نوع ECC ونك التي لا تتوافق مع DIMM لا تدعم نقل الذاكرة	الذاكرة الرئيسية
ITE 8716F الأكثر استخداماً، Super I/O توفر وظيفة Low Pin Count Interface تدعم تقنية وسائل التحكم في البيئة مراقب لمعومة حللة الأجهزة مراقب في سعة لمروحة ITE من "Smart Guardian" وظيفة	ITE 8716F الأكثر استخداماً، Super I/O توفر وظيفة Low Pin Count Interface تدعم تقنية وسائل التحكم في البيئة مراقب لمعومة حللة الأجهزة مراقب في سعة لمروحة ITE من "Smart Guardian" وظيفة	Super I/O
متكامل IDE متحكم Ultra DMA 33 / 66 / 100 / 133 نقل بتقنية وضع رئيسي PIO Mode 0~4 دعم وضع	متكامل IDE متحكم Ultra DMA 33 / 66 / 100 / 133 نقل بتقنية وضع رئيسي PIO Mode 0~4 دعم وضع	منفذ IDE
متكامل Serial ATA متحكم نقل البيانات بسرعات تصل إلى 3 جيجابت/ثانية. 2.0 الإصدار SATA مطابقة لمواصفات	متكامل Serial ATA متحكم نقل البيانات بسرعات تصل إلى 3 جيجابت/ثانية. 2.0 الإصدار SATA مطابقة لمواصفات	SATA II
Realtek RTL8201CL PHY قلو ض نقائي 100/10 ميغا بايت جيجا بت/ثانية إمكانية نقل لمزدوج لكل/لصفي	Realtek RTL8201CL PHY قلو ض نقائي 100/10 ميغا بايت جيجا بت/ثانية إمكانية نقل لمزدوج لكل/لصفي	شبكة داخلية
Realtek ALC861VD(Ver 6.x) Realtek ALC888(Ver 5.x) 5.1 قنوات لخرج الصوت(Ver 6.x) 7.1 قنوات لخرج الصوت(Ver 5.x) تدعم تقنية لصوت علي تعريف من	Realtek ALC662(NF520-A2 TE)(Ver 6.x) Realtek ALC861VD(NF520-A2SE)(Ver 6.x) Realtek ALC888(Ver 5.x) 5.1 قنوات لخرج الصوت(Ver 6.x) 7.1 قنوات لخرج الصوت(Ver 5.x) تدعم تقنية لصوت علي تعريف من	كوديك الصوت

NF520-A2 TE/NF520-A2 SE/NF520-A2

NF520-A2		NF520-A2 TE/NF520-A2 SE			
عدد 3	فتحة PCI	عدد 3	فتحة PCI	الفتحات	
عدد 1	فتحة PCI Express x 16	عدد 1	فتحة PCI Express x 16		
عدد 2	فتحة PCI Express x 1	عدد 2	فتحة PCI Express x 1		
عدد 1	مقذ محرك أقراص مرنة	عدد 1	مقذ محرك أقراص مرنة	المنافذ على سطح اللوحة	
عدد 1	مقذ طابعة	عدد 1	مقذ طابعة		
عدد 1	مقذ IDE	عدد 1	مقذ IDE		
عدد 2	مقذ SATA	عدد 4	مقذ SATA		
عدد 1	مقذ اللوحة الأممية	عدد 1	مقذ اللوحة الأممية		
عدد 1	مقذ الصوت الأممي	عدد 1	مقذ الصوت الأممي		
عدد 1	مقذ CD-IN	عدد 1	مقذ CD-IN		
عدد 1	مقذ خرج S/PDIF	عدد 1	مقذ خرج S/PDIF		
عدد 1	وصلة مروحة وحدة المعالجة المركزية	عدد 1	وصلة مروحة وحدة المعالجة المركزية		
عدد 1	وصلة مروحة النظم	عدد 1	وصلة مروحة النظم		
عدد 1	وصلة مسح CMOS	عدد 1	وصلة مسح CMOS		
عدد 1	وصلة فتح الهيكل (اختياري)	عدد 1	وصلة فتح الهيكل (اختياري)		
عدد 2	مقذ USB	عدد 3	مقذ USB		
عدد 1	مقذ توصيل الطاقة (24دوس)	عدد 1	مقذ توصيل الطاقة (24دوس)		
عدد 1	مقذ توصيل الطاقة (4دبليس)	عدد 1	مقذ توصيل الطاقة (4دبليس)		
عدد 1	لوحة مفاتيح PS/2	عدد 1	لوحة مفاتيح PS/2		منافذ دخل/خروج اللوحة الخلفية
عدد 1	مؤس PS/2	عدد 1	مؤس PS/2		
عدد 1	مقذ تسلسلي	عدد 1	مقذ تسلسلي		
عدد 1	مقذ شبكة لتصل محلية	عدد 1	مقذ شبكة لتصل محلية		
عدد 4	منافذ USB	عدد 4	منافذ USB		
عدد 3	مقيس صوت (Ver 6.x)	عدد 3	مقيس صوت (Ver 6.x)		
عدد 6	مقيس صوت (Ver 5.x)	عدد 6	مقيس صوت (Ver 5.x)		
RAID 0 / 1		RAID 0 / 1 / 0+1		مزايا خاصة	
200 مم (عرض) X 293 مم (ارتفاع)		200 مم (عرض) X 293 مم (ارتفاع)		حجم اللوحة	
Windows 2000 / XP / VISTA		Windows 2000 / XP / VISTA		دعم أنظمة التشغيل	
بخطأ في إضاءة أو إزالة الدعم لأي نظام تشغيل باخطأ أو Biostar تخنظ بيون إخطل.		بخطأ في إضاءة أو إزالة الدعم لأي نظام تشغيل باخطأ أو Biostar تخنظ بيون إخطل.			

JAPANESE

	NF520-A2 TE/NF520-A2 SE	NF520-A2
CPU	Socket AM2 AMD Athlon 64 / Athlon 64 FX / Athlon 64 x2/ Sempron プロセッサ AMD 64アーキテクチャでは、32ビットと64ビット計算が可能 ハイパートランスポートとクールアンドクワイアットをサポートします	Socket AM2 AMD Athlon 64 / Athlon 64 FX / Athlon 64 x2/ Sempron プロセッサ AMD 64アーキテクチャでは、32ビットと64ビット計算が可能 ハイパートランスポートとクールアンドクワイアットをサポートします
FSB	1G のバス幅までハイパートランスポートをサポートします	1G のバス幅までハイパートランスポートをサポートします
チップセット	nForce 520	nForce 520LE
メインメモリ	DDR2 DIMMスロット x 4 各DIMMは 256/512MB & 1GB/2GB DDR2をサポート 最大メモリ容量8GB デュアルチャンネルモードDDR2メモリモジュール DDR2 533 / 667 / 800をサポート 登録済みDIMMとECC DIMMはサポートされません	DDR2 DIMMスロット x 4 各DIMMは 256/512MB & 1GB/2GB DDR2をサポート 最大メモリ容量8GB デュアルチャンネルモードDDR2メモリモジュール DDR2 533 / 667 / 800をサポート 登録済みDIMMとECC DIMMはサポートされません
Super I/O	ITE 8716F もともと一般に使用されるレガシーSuper I/O機能を採用しています。 低ピンカウントインターフェイス 環境コントロールイニシアチブ、 H/Wモニター ファン速度コントローラ/ モニター ITEの「スマートガーディアン」機能	ITE 8716F もともと一般に使用されるレガシーSuper I/O機能を採用しています。 低ピンカウントインターフェイス 環境コントロールイニシアチブ、 H/Wモニター ファン速度コントローラ/ モニター ITEの「スマートガーディアン」機能
IDE	統合IDEコントローラ Ultra DMA 33 / 66 / 100 / 133バスマスタモード PIO Mode 0~4のサポート、	統合IDEコントローラ Ultra DMA 33 / 66 / 100 / 133バスマスタモード PIO Mode 0~4のサポート、
SATA II	統合シリアルATAコントローラ 最高3 Gb/秒のデータ転送速度 SATAバージョン2.0仕様に対応。	統合シリアルATAコントローラ 最高3 Gb/秒のデータ転送速度 SATAバージョン2.0仕様に対応。
LAN	Realtek RTL8201CL PHY 10 / 100 Mb/秒のオートネゴシエーション 半/全二重機能	Realtek RTL8201CL PHY 10 / 100 Mb/秒のオートネゴシエーション 半/全二重機能

NF520-A2 TE/NF520-A2 SE/NF520-A2

	NF520-A2 TE/NF520-A2 SE	NF520-A2
サウンド Codec	Realtek ALC662 (NF520-A2 TE) (Ver 6.x) Realtek ALC861VD (NF520-A2SE) (Ver 6.x) Realtek ALC 888 (Ver 5.x) 5.1 チャンネルオーディオアウト (Ver 6.x) 7.1 チャンネルオーディオアウト (Ver 5.x) ハイデフィニションオーディオのサポート	Realtek ALC 861VD (Ver 6.x) Realtek ALC 888 (Ver 5.x) 5.1 チャンネルオーディオアウト (Ver 6.x) 7.1 チャンネルオーディオアウト (Ver 5.x) ハイデフィニションオーディオのサポート
スロット	PCIスロット x3 PCI Express x16スロット x1 PCI Express x 1スロット x2	PCIスロット x3 PCI Express x16スロット x1 PCI Express x 1スロット x2
オンボードコ ネクタ	フロッピーコネクタ x1 プリンタポートコネクタ x1 IDEコネクタ x1 SATAコネクタ x4 フロントパネルコネクタ x1 フロントオーディオコネクタ x1 CDインコネクタ x1 S/PDIFアウトコネクタ x1 CPUファンヘッダ x1 システムファンヘッダ x1 CMOS クリアヘッダ x1 シャーシオープンヘッダ(オプション) x1 USBコネクタ x3 電源コネクタ(24ピン) x1 電源コネクタ(4ピン) x1	フロッピーコネクタ x1 プリンタポートコネクタ x1 IDEコネクタ x1 SATAコネクタ x2 フロントパネルコネクタ x1 フロントオーディオコネクタ x1 CDインコネクタ x1 S/PDIFアウトコネクタ x1 CPUファンヘッダ x1 システムファンヘッダ x1 CMOS クリアヘッダ x1 シャーシオープンヘッダ(オプション) x1 USBコネクタ x2 電源コネクタ(24ピン) x1 電源コネクタ(4ピン) x1
背面パネル I/O	PS/2キーボード x1 PS/2マウス x1 シリアルポート x1 LANポート x1 USBポート x4 オーディオジャック (Ver 6.x) x3 オーディオジャック (Ver 5.x) x6	PS/2キーボード x1 PS/2マウス x1 シリアルポート x1 LANポート x1 USBポート x4 オーディオジャック (Ver 6.x) x3 オーディオジャック (Ver 5.x) x6
ボードサイズ	200 mm (幅) X 293 mm (高さ)	200 mm (幅) X 293 mm (高さ)
特殊機能	RAID 0 / 1 / 0+1のサポート	RAID 0 / 1のサポート
OSサポート	Windows 2000 / XP / VISTA Bicstarは事前のサポートなしにOSサポートを追加ま たは削除する権利を留保します。	Windows 2000 / XP / VISTA Bicstarは事前のサポートなしにOSサポートを追加ま たは削除する権利を留保します。

2008/04/07